

XGT Panel Series is a brand new HMI product with an intensive and advanced technology of LSIS to cope with the rapidly changing market situation. It is an innovative product having both reliability and convenience based on the Windows CE. With the user-oriented convenience, it offers high resolution display, prompt data transmission and processing, and an user-friendly interface. LSIS provides the Leading Solution to the automation field with the XGT Panel Series. We are confident of our XGT Panel Series which contains high technology and our commitment to quality at the HMI market.

With the user-oriented convenience, it offers high resolution display, prompt data transmission and processing, and an user-friendly interface.

# Human Machine Interface **XGT Panel**



**Leading Innovation,  
Creating Tomorrow**





## LSIS creates the core automation solutions for the fields ranging from production facilities to information systems.

It is the device and software operable using a designed screen for users to monitor and control the operating status of given facilities and equipments. Windows CE platform based XGT panel is a user-friendly solution, providing convenient, clear and realistic display, prompt data transmission and processing as well as easy environments.

Based on the advanced technologies, LSIS satisfies various requirements of clients, from unit facilities to advanced industrial fields, leading the HMI market.

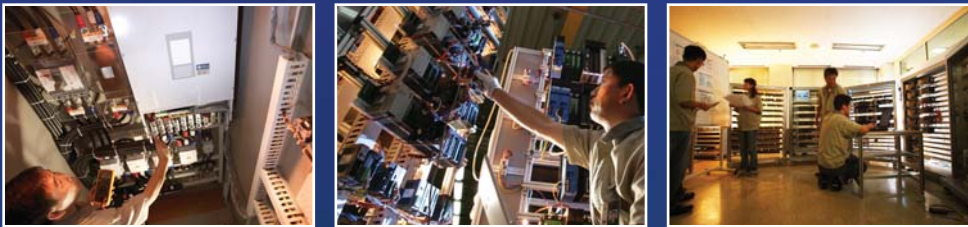

## C O N T E N T S

XGT Panel .....	04
XGT Panel iXP Series .....	06
XGT Panel eXP Series .....	08
Products Line Up .....	10
<b>Feature</b>	
Hardware Related Functions .....	12
XP-Builder .....	16
Software Related Functions .....	18
Advanced Functions .....	20
Link with Controllers .....	22
External Monitoring Function .....	24
System Block Diagram .....	26
<b>Our Solution</b> .....	28
<b>Products</b>	
iXP Series .....	30
eXP Series .....	32
XP Series .....	34
<b>List of Communication Drivers</b> .....	36

**XGT**  
Panel



Data Logging

NO	DATE	TIME	POWER	SPEED	LEVEL
0	2007/03/30	17:37:12	2048	800	204
1	2007/03/30	17:37:17	4	1890	629
2	2007/03/30	17:37:22	1024	3100	1064
3	2007/03/30	17:37:27	2	4350	1479
4	2007/03/30	17:37:32	512	5600	1904
5	2007/03/30	17:37:37	1	6950	2329
6	2007/03/30	17:37:42	256	8100	2754
7	2007/03/30	17:37:47	6	9250	3179
8	2007/03/30	17:37:52	128	10600	3604
9	2007/03/30	17:37:57	-32768	11850	4029
10	2007/03/30	17:38:02	64	13100	4454
11	2007/03/30	17:38:07	16384	14350	4879
12	2007/03/30	17:38:12	32	15600	5304
13	2007/03/30	17:38:17	8192	16850	5729

Line Up! Line Down! Page Up! Page Down! Exit!

Control Panel

Printer Position: 101, 102, 103, 104, 105, 106, 107, 108, 109, 110, 111, 112, 113, 114, 115, 116, 117, 118, 119, 120, 121, 122, 123, 124, 125, 126, 127, 128, 129, 130, 131, 132, 133, 134, 135, 136, 137, 138, 139, 140, 141, 142, 143, 144, 145, 146, 147, 148, 149, 150, 151, 152, 153, 154, 155, 156, 157, 158, 159, 160, 161, 162, 163, 164, 165, 166, 167, 168, 169, 170, 171, 172, 173, 174, 175, 176, 177, 178, 179, 180, 181, 182, 183, 184, 185, 186, 187, 188, 189, 190, 191, 192, 193, 194, 195, 196, 197, 198, 199, 200, 201, 202, 203, 204, 205, 206, 207, 208, 209, 210, 211, 212, 213, 214, 215, 216, 217, 218, 219, 220, 221, 222, 223, 224, 225, 226, 227, 228, 229, 230, 231, 232, 233, 234, 235, 236, 237, 238, 239, 240, 241, 242, 243, 244, 245, 246, 247, 248, 249, 250, 251, 252, 253, 254, 255, 256, 257, 258, 259, 260, 261, 262, 263, 264, 265, 266, 267, 268, 269, 270, 271, 272, 273, 274, 275, 276, 277, 278, 279, 280, 281, 282, 283, 284, 285, 286, 287, 288, 289, 290, 291, 292, 293, 294, 295, 296, 297, 298, 299, 300, 301, 302, 303, 304, 305, 306, 307, 308, 309, 310, 311, 312, 313, 314, 315, 316, 317, 318, 319, 320, 321, 322, 323, 324, 325, 326, 327, 328, 329, 330, 331, 332, 333, 334, 335, 336, 337, 338, 339, 340, 341, 342, 343, 344, 345, 346, 347, 348, 349, 350, 351, 352, 353, 354, 355, 356, 357, 358, 359, 360, 361, 362, 363, 364, 365, 366, 367, 368, 369, 370, 371, 372, 373, 374, 375, 376, 377, 378, 379, 380, 381, 382, 383, 384, 385, 386, 387, 388, 389, 390, 391, 392, 393, 394, 395, 396, 397, 398, 399, 400, 401, 402, 403, 404, 405, 406, 407, 408, 409, 410, 411, 412, 413, 414, 415, 416, 417, 418, 419, 420, 421, 422, 423, 424, 425, 426, 427, 428, 429, 430, 431, 432, 433, 434, 435, 436, 437, 438, 439, 440, 441, 442, 443, 444, 445, 446, 447, 448, 449, 450, 451, 452, 453, 454, 455, 456, 457, 458, 459, 460, 461, 462, 463, 464, 465, 466, 467, 468, 469, 470, 471, 472, 473, 474, 475, 476, 477, 478, 479, 480, 481, 482, 483, 484, 485, 486, 487, 488, 489, 490, 491, 492, 493, 494, 495, 496, 497, 498, 499, 500, 501, 502, 503, 504, 505, 506, 507, 508, 509, 510, 511, 512, 513, 514, 515, 516, 517, 518, 519, 520, 521, 522, 523, 524, 525, 526, 527, 528, 529, 530, 531, 532, 533, 534, 535, 536, 537, 538, 539, 540, 541, 542, 543, 544, 545, 546, 547, 548, 549, 550, 551, 552, 553, 554, 555, 556, 557, 558, 559, 560, 561, 562, 563, 564, 565, 566, 567, 568, 569, 570, 571, 572, 573, 574, 575, 576, 577, 578, 579, 580, 581, 582, 583, 584, 585, 586, 587, 588, 589, 590, 591, 592, 593, 594, 595, 596, 597, 598, 599, 600, 601, 602, 603, 604, 605, 606, 607, 608, 609, 610, 611, 612, 613, 614, 615, 616, 617, 618, 619, 620, 621, 622, 623, 624, 625, 626, 627, 628, 629, 630, 631, 632, 633, 634, 635, 636, 637, 638, 639, 640, 641, 642, 643, 644, 645, 646, 647, 648, 649, 650, 651, 652, 653, 654, 655, 656, 657, 658, 659, 660, 661, 662, 663, 664, 665, 666, 667, 668, 669, 670, 671, 672, 673, 674, 675, 676, 677, 678, 679, 680, 681, 682, 683, 684, 685, 686, 687, 688, 689, 690, 691, 692, 693, 694, 695, 696, 697, 698, 699, 700, 701, 702, 703, 704, 705, 706, 707, 708, 709, 710, 711, 712, 713, 714, 715, 716, 717, 718, 719, 720, 721, 722, 723, 724, 725, 726, 727, 728, 729, 730, 731, 732, 733, 734, 735, 736, 737, 738, 739, 740, 741, 742, 743, 744, 745, 746, 747, 748, 749, 750, 751, 752, 753, 754, 755, 756, 757, 758, 759, 760, 761, 762, 763, 764, 765, 766, 767, 768, 769, 770, 771, 772, 773, 774, 775, 776, 777, 778, 779, 780, 781, 782, 783, 784, 785, 786, 787, 788, 789, 790, 791, 792, 793, 794, 795, 796, 797, 798, 799, 800, 801, 802, 803, 804, 805, 806, 807, 808, 809, 810, 811, 812, 813, 814, 815, 816, 817, 818, 819, 820, 821, 822, 823, 824, 825, 826, 827, 828, 829, 830, 831, 832, 833, 834, 835, 836, 837, 838, 839, 840, 841, 842, 843, 844, 845, 846, 847, 848, 849, 850, 851, 852, 853, 854, 855, 856, 857, 858, 859, 860, 861, 862, 863, 864, 865, 866, 867, 868, 869, 870, 871, 872, 873, 874, 875, 876, 877, 878, 879, 880, 881, 882, 883, 884, 885, 886, 887, 888, 889, 890, 891, 892, 893, 894, 895, 896, 897, 898, 899, 900, 901, 902, 903, 904, 905, 906, 907, 908, 909, 910, 911, 912, 913, 914, 915, 916, 917, 918, 919, 920, 921, 922, 923, 924, 925, 926, 927, 928, 929, 930, 931, 932, 933, 934, 935, 936, 937, 938, 939, 940, 941, 942, 943, 944, 945, 946, 947, 948, 949, 950, 951, 952, 953, 954, 955, 956, 957, 958, 959, 960, 961, 962, 963, 964, 965, 966, 967, 968, 969, 970, 971, 972, 973, 974, 975, 976, 977, 978, 979, 980, 981, 982, 983, 984, 985, 986, 987, 988, 989, 990, 991, 992, 993, 994, 995, 996, 997, 998, 999, 1000

Display: Line Setup Manual Run Mode

Card 4GB 4GB 16GB 16GB

# XGT Panel

neXt Generation Technology

We are in the forefront with advanced technologies for clients.



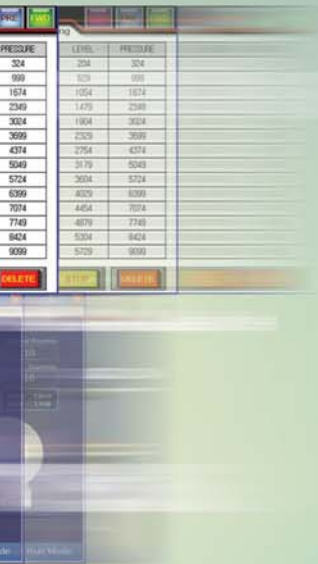

XGT Panel is a brand new HMI product with an intensive and advanced technology of LSIS to cope with the rapidly changing market. It is an innovative product having both reliability and convenience based on Window CE Platform. With the user-oriented convenience, it offers high-resolution, realistic display, prompt data transmission and processing and user-friendly interface. LSIS, offering a Leading Solution in the automation field, proudly presents the XGT Panel series at the HMI market with the advanced technologies and product quality, following the XGT PLC.

## Excellent Performance & Convenient Functions

- ☑ Clear and high-resolution display with 16.7M TFT and 65K TFT colors
- ☑ Various vector symbols and high quality raster symbols
- ☑ Supports a wide range of graphic formats including BMP, JPG, GIF, WMF
- ☑ Simple video clips with GIF drawing
- ☑ 10/100 BASE-T Ethernet interface as a default
- ☑ Convenient and easy screen editing
- ☑ Enhanced data management function (Logging, Recipe and Alarm)
- ☑ Read function of the controller's status information (diagnosis, monitoring and maintenance)
- ☑ Multi-lingual display of up to 12 languages and a batch language changing function
- ☑ Offline simulation program (link with the XG5000 simulator)
- ☑ HMI S/W tag function (easy to change the device address mapped to graphic objects)
- ☑ USB Host/Device function for using various PC devices (mouse, keyboard, and etc.)
- ☑ Sufficient memory space for project
- ☑ Excellent performance and convenient functions





XGT  
Panel



# XGT Panel iXP Series

*intelligent XGT Panel*

**Convenient control with a single touch!**

A user-oriented interface, enhanced performance, and soft and quick screen switching and respond speed to touch!

Meet iXP series of LSIS that genuinely and fully connects humans with equipments.





It is highly competitive using the user-friendly technologies.

- ☑ Quick screen switching and response speed to touch
- ☑ 16.7M TFT colored LCD
- ☑ Large drawing / backup memory (Drawing-128MB, Backup-1MB)
- ☑ Sound Output support
- ☑ Various interfaces
  - USB Host 3ch (Front: 1, Rear: 2), Device 1ch (Front)
  - SD card
  - Various communication drivers provided
- ☑ Presence sensor applied (within 1m)

## High Speed

High-performance 1GHz CPU is installed to improve the data and screen switching speed, and Windows CE 6.0 Professional OS is adopted to execute NET-based external applications.

## Large Memory

Large device memory is provided to save mass data.

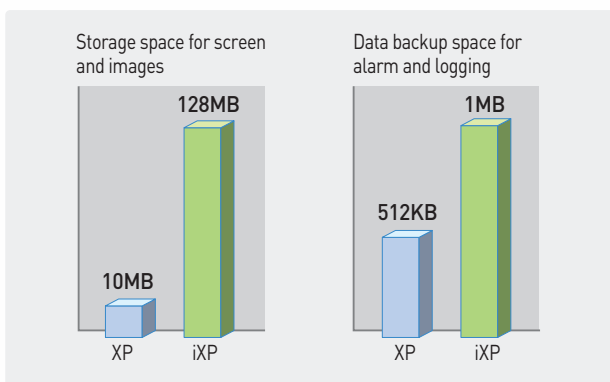

## Presence Sensor

Sensor detects movement within 1m, to control the backlight, ensuring a longer life of the product.

## More Colorful

High luminance/resolution LCD with an LED backlight and 24 bit colors to express clear and vivid colors of 16,777,216.





XGT Panel

# eXP Series

*efficient XGT Panel*



## Effective Control and Monitoring Solution Cost-Efficient eXP!

- ☑ Simple Design
- ☑ 7" and 10.2" wide-screen sizes TFT color LCD
- ☑ Wide variety of communication interfaces
  - 3-channel serial communication
  - Ethernet
- ☑ Large memory for drawing (64MB)
- ☑ RTC function (maintained by battery)
- ☑ Convenient downloading/uploading of drawings via USB port in the front





### Higher Level of Performance

Gives superior performance with improved CPU compared with the existing products

### Wider Variety of Communication Interfaces

Communicable simultaneously with PLC, barcode reader, VFD, temperature controller

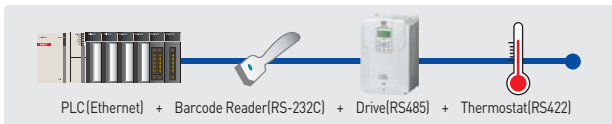

### Slimmer and Lighter in Weight

20% lighter than previous products, provides more space and lightens user's panels





# Products Line-up

Window CE-based new HMI developed with advanced technologies of LSIS to optimize the user experience

## XGT Panel

		15" (38Cm)	12.1" (31Cm)	10.4" (26Cm)
iXP Series	<b>Premium</b> Ethernet I/F Serial I/F (FIRS-232C)    Serial I/F (FIRS422/485) USB I/F    SD카드 I/F	<b>iXP90-TTA</b>  TFT 16,777,216 colors XGA(1024 x 768)	<b>iXP80-TTA</b>  TFT 16,777,216 colors SVGA(800 x 600)	<b>iXP70-TTA</b>  TFT 16,777,216 colors SVGA(800 x 600)
	<b>eXP Series</b> <b>Standard</b> Serial I/F (FIRS-232C)    Serial I/F (FIRS422/485)    Serial I/F (FIRS-485) USB I/F    Ethernet I/F			<b>10.2" (25.9Cm)</b> <b>eXP60-TTA</b>  TFT 65,536 colors WGA(800 x 480)
XP Series	<b>General</b> Ethernet I/F    Serial I/F (FIRS-232C)    Serial I/F (FIRS422/485) USB I/F    CF Card I/F    Expansion port	<b>XP90-TTA</b>  TFT 65,536 colors XGA(1024 x 768)	<b>XP80-TTA</b>  TFT 65,536 colors SVGA(800 x 600)	<b>XP70-TTA</b>  TFT 65,536 colors VGA(640 x 480)





8.4"(21Cm)

**iXP50-TTA**



TFT 16,777,216 colors  
SVGA(800 × 600)

7"(17.7Cm)

**eXP40-TTA**  
**eXP40-TTE** \*1



TFT 65,536 colors  
WVGA(800 × 480)

8.4"(21Cm)

7"(17.7Cm)

5.7"(14Cm)

**XP50-TTA**



TFT 65,536 colors  
VGA(640 × 480)

**XP40-TTA**  
**XP40-TTE** \*1 \*2 \*3



TFT 65,536 colors  
WVGA(800 × 480)

**XP30-TTA**  
**XP30-TTE** \*1 \*2 \*3



TFT 65,536 colors  
QVGA(320 × 240)

**XP30-BTA**  
**XP30-BTE** \*1 \*2 \*3



STN MONO [8-column Gray]  
QVGA(320 × 240)

\*1: Ethernet I/F not supported. \*2: CF card I/F not supported. \*3: Expansion port not supported.

## Hardware Related Functions **iXP**

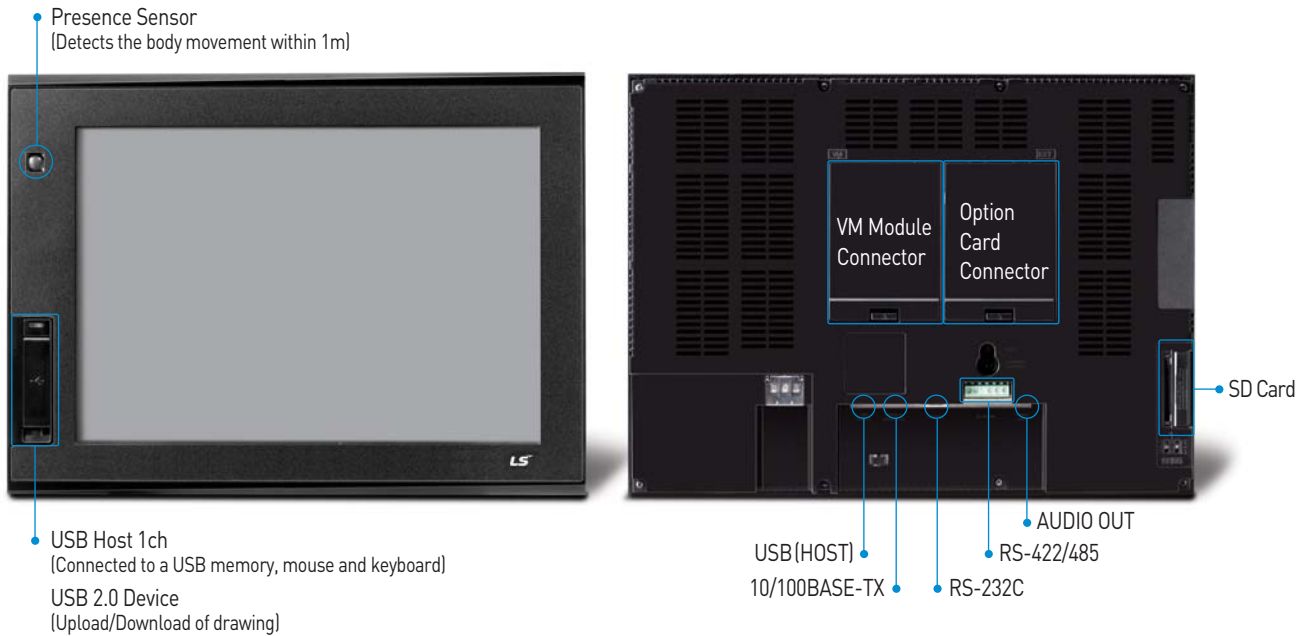

### **iXP** 1 Respective Front USB Host/Device Channel

- An additional USB host channel is installed in the front panel.
- A front USB host is used to connect to a USB memory, mouse and keyboard.
- A front USB device port is used to change the XP-Runtime without opening a control panel or download/upload the drawing file created using XP-Builder.



### **iXP** Sound Output Function (For all iXP models)

- The sound files (wav, mp3) registered using XP-Builder can be output to speakers connected to HMI.
- An alarm is generated via speakers to warn operators.
- Up to 512 sound files can be saved.



### **iXP** Function to use SD Cards

iXP supports additional SD memory cards along with previous USB memory to diversify the backup means.

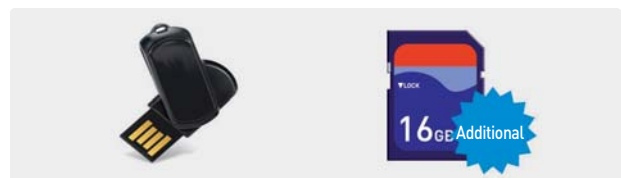



## iXP Presence Sensor (For all iXP models)

- The XP presence sensor detects movement within 1m to turn on a backlight.
- When not used, it turns OFF the screen to maintain a longer lifespan of the backlight.

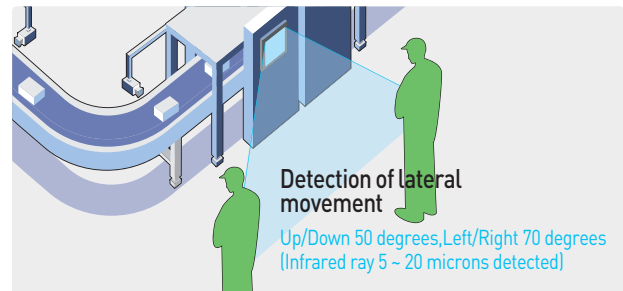
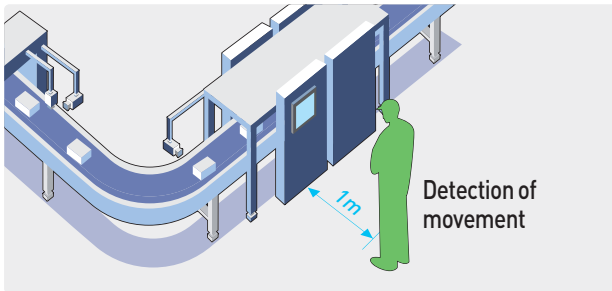

## Hardware Related Functions **iXP** **eXP** **XP**

### Ethernet method for Quick Transmission of Mass Data

- Ethernet method has improved the transmission speed. Compared to the conventional RS-232C method, a quicker transmission speed: 115kbps → 10/100Mbps
- Regardless of the memory capacity, the drawing files can be quickly uploaded/ downloaded, and logging/alarm/recipe data can be conveniently used.
- Ethernet method is used for various production data collection, monitoring and control using PC.

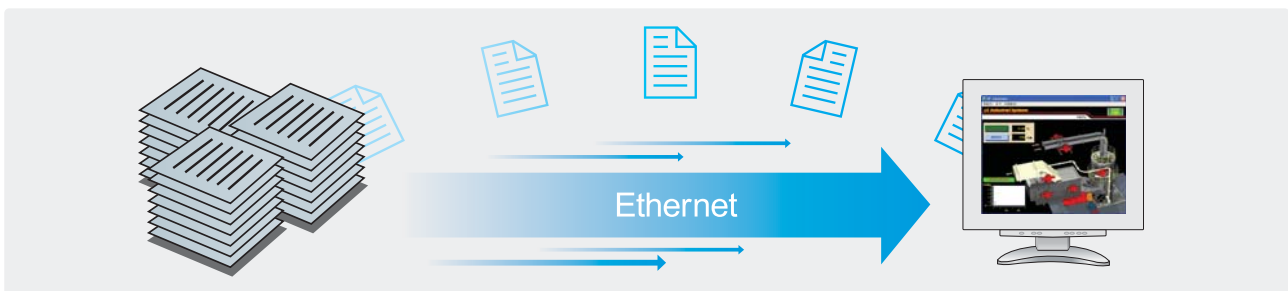

### Barcode Scanner Communication

- ASCII data imported by accessing a barcode scanner from XGT Panel can be saved in the user-assigned PLC or XGT Panel's internal memory.
- Complete Bit can be randomly saved. It allows users to check whether the XGT Panel has read the data without errors.
- Communication with barcodes is possible by using the RS-232C interface installed in the XGT Panel.

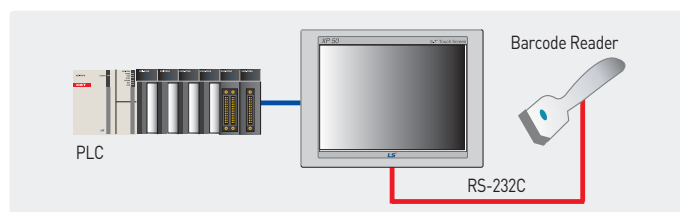

### Providing Various Communication Channels

Using RS-232C, RS-422/485 and Ethernet, XP and iXP are capable of communicating with up to 4 and 6 types of controllers, respectively. Refer to the system block diagram (TTE type does not have an Ethernet module).

## Hardware Related Functions **eXP**

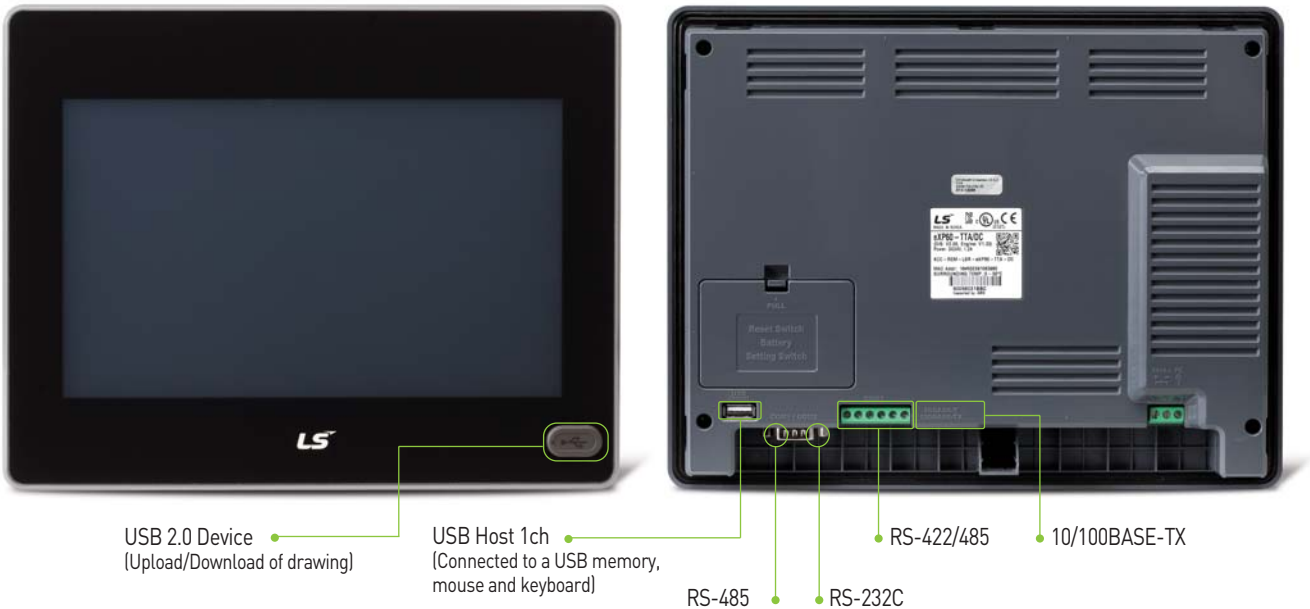

### **eXP** USB Port in the Front for Devices

- With USB port in the front, no need to open the control panel to apply changes to XP-Runtime or download/upload drawing files made in XP-Builder



### **eXP** 3-Channel Serial Communication

- Simultaneously communicable by RS-485, RS-232C, RS-422/485
- D-Sub 9-pin terminal includes COM1 and COM2

### **eXP** RTC Function

- RTC (Real Time Clock) function operates with a battery even with the power off
- HMI time setting is adjustable quickly using XP-Builder

### **eXP** High Performance and Cost-Efficient

- 30% high performance and low cost





## Hardware Related Functions **XP**



USB Host  
CF card: effective use of USB memory

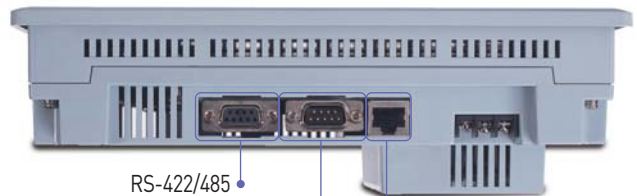

RS-422/485  
RS-232C  
Ethernet

### **XP** USB Host

- 2 USB interface channels
- Various access devices can be used using the USB I/F.
- Access to mouse, keyboard, a USB external hard disk, barcode reader and USB hub is possible, Access to mouse, keyboard, a USB external hard disk, barcode reader and USB hub is possible. Continuous upgrades and developments to cope with other drivers are under progress.

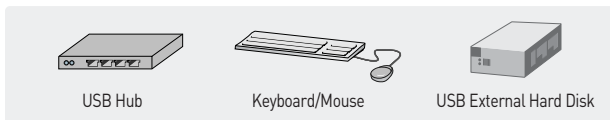

### **XP** <sup>A type</sup> USB Cable (XPO-USBC)

- USB cable is used for screen data transmission and XP-Runtime updates.
- The versions before XP-Builder 1.30 are not installed with the USB driver, thus it must be installed.



### **XP** Effective Use of USB Memory

- PLC data can be saved in a CF card or USB memory. If necessary, they are converted into a CSV format to be used to prepare daily and monthly reports.
- When the drawing files using XP-Builder are saved in a CF card or a USB memory and copied to the XGT Panel, they can be executed without being sent via cables.
- When there are several XGT Panels, one CF card or USB memory can be used to copy each XGT panel, allowing a setup.
- A CF card or a USB memory can be used for engine updates and upload/download of drawing files.

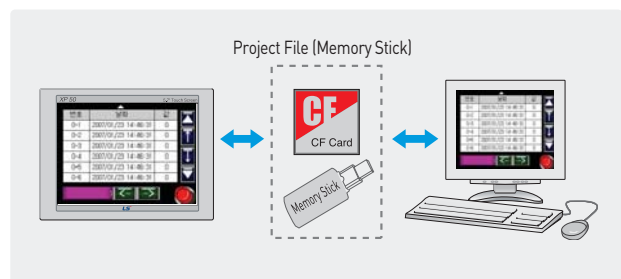

## XP-Builder

XGT Panel offers easy and user-friendly multi-interface.

### XP-Builder Functions

#### Implementation of multiple programs

In order to use the previously created drawing data for a new drawing, more than 2 XP-Builder programs are executed simultaneously.

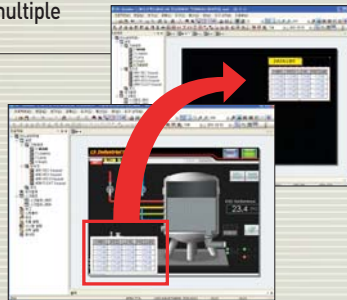

#### Function to check data

- To check for any error on the data created, and errors can be corrected by clicking on them.
- The specific description of error created is displayed.



#### Cross-reference function of devices

Devices used for drawing data and tags are displayed.



### Drawing Editor: XP-Builder

#### Project Window

Aligned for easier addition and edition of project view screens and special functions.

#### Data Element Window

- Displays the objects on a screen currently shown.
- When double-clicked, a window on setting the properties appears.

#### Output Window

- Displays the error checked on drawing data and the search results.
- It displays the specific description of the errors created.

#### Tool Box

Used to select an object or draw a shape.

#### Library Window

- Library is divided by category for easier use, and preview is used for drawing.
- Convenient for users to register and delete the Library.
- Drag & Drop is used for a screen insertion.

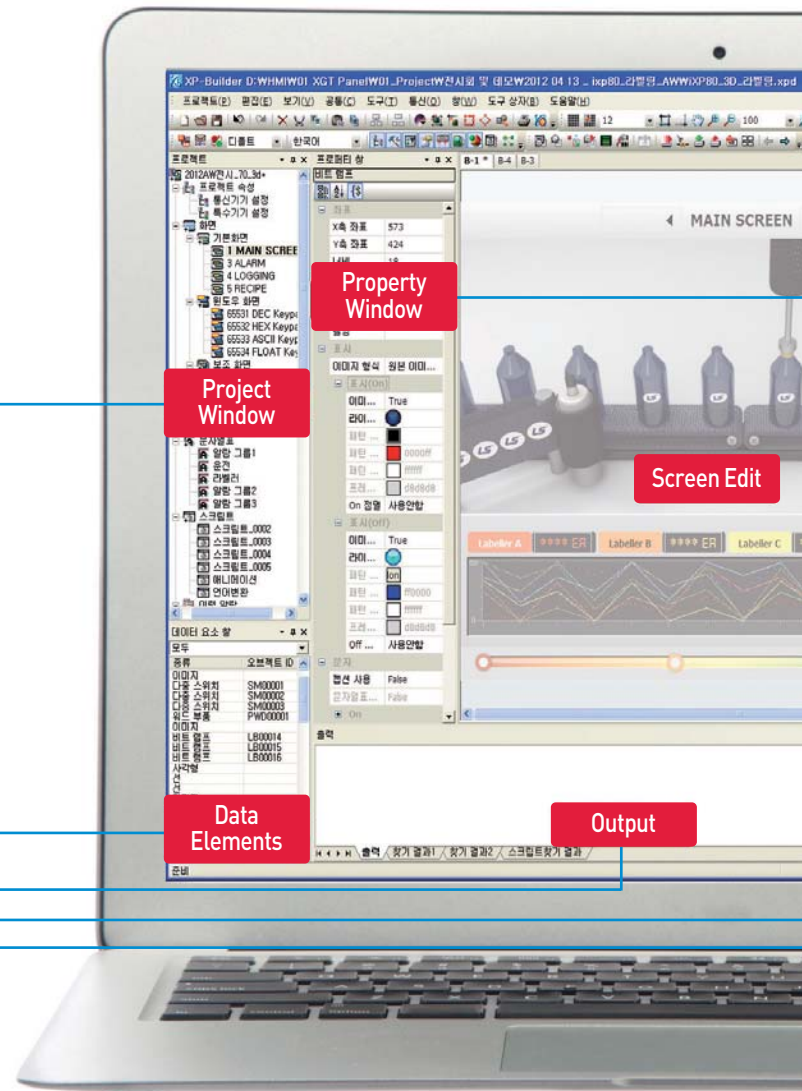



### Tag function

- Users can set device address by desired name, which can be used in an object.
- When a set device is tagged to an object, addresses can be changed, collectively
- Up to 10,000 tags can be registered.

번호	태그명	장치주소	주소	설명
1	SourceA	BIT	HW0001.F	
2	SourceB	BIT	HW0002.F	
3	SourceA_V1	BIT	HW0002.E	
4	SourceA_V2	BIT	HW0002.E	
5	SourceA_V3	BIT	HW0002.E	
6	SourceB_V1	BIT	HW0002.E	
7	SourceB_V2	BIT	HW0002.E	
8	SourceB_V3	BIT	HW0002.E	

### Various fonts with convenient setting options

- Windows fonts used in a PC can be transmitted to HMI for use.
- When using Windows fonts, font attributes (Italic, bold and underline) can be used as well.
- Various font sizes including True Type are supported.
- Supports the Unicode, characters of other countries such as the standard font and high-quality fonts are beautifully displayed.
- Sophisticated and elegant text can be used to create a screen using various fonts.

Arial : ABCDEFGHIJKLMNOPQRSTUVWXYZ  
 Book : ABCDEFGHIJKLMNOPQRSTUVWXYZ  
 Impact : ABCDEFGHIJKLMNOPQRSTUVWXYZ  
 Helvetica : ABCDEFGHIJKLMNOPQRSTUVWXYZ  
 Tahoma : ABCDEFGHIJKLMNOPQRSTUVWXYZ  
 Time : ABCDEFGHIJKLMNOPQRSTUVWXYZ  
 Verdana : ABCDEFGHIJKLMNOPQRSTUVWXYZ

가나다라마바사아자차카타파하  
 가나다라마바사아자차카타파하  
 가나다라마바사아자차카타파하  
 가나다라마바사아자차카타파하

### Animation function

- When GIF format is used, animation effects can be realized depending on the state of given bit.
- When a video clip on given site is created into GIF to be added to a drawing screen, more accurate information can be delivered to users. (Video clip files can be created using the commercial software for GIF creation)



### User-oriented screen UI

#### Providing a flexible script language

- Provides a screen UI that can be easily used considering user's experiences.
- Divided into categories so that a graphic library can be easily searched.
- Various graphic libraries are offered for enhanced usability.

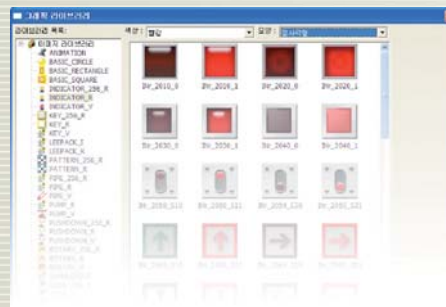

#### Property Window

This function enables users to change properties of numerous objects at once, so that users do not have to open each object like a button or a lamp for modification.

- Numerous objects on the screen can be selected at once to replace the pictures, enhancing users' convenience.
- When modifying several objects, only the objects with the same function should be selected.
- Users can correct both pictures and properties.

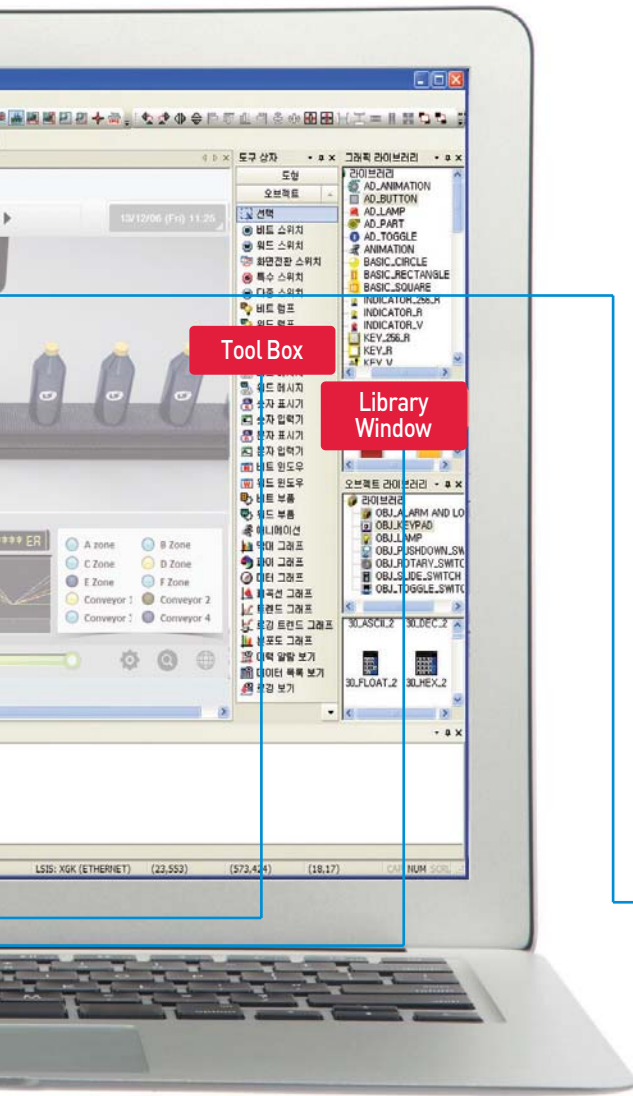

## Software Related Functions

### Multi-lingual support & conversion to respond to the global enterprise environments

- In response to enterprise environment of global era, up to 12 languages can be simultaneously converted and users can select a language depending on his/her nationality.
- When desired character string is registered in a table, a language can be converted into a device value and switched upon operation.
- The languages supported include Korean, English, Chinese (PRC/Taiwan), Japanese, French, Turkish, Iranian (Persian), German, Greek, Russian, Italian, Norwegian, Polish, Portuguese and Spanish, all of which are supported in Windows.

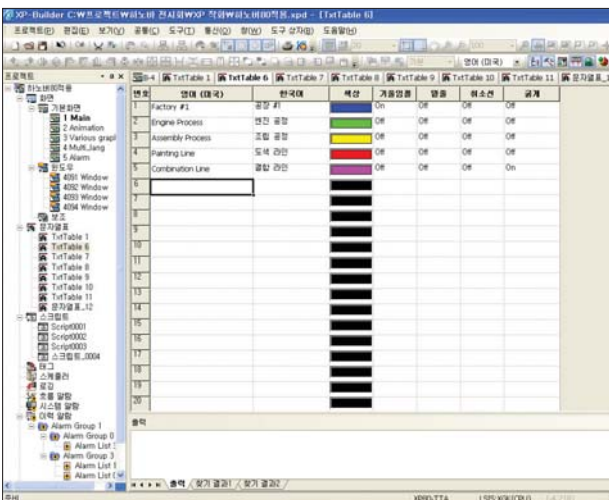

### Strict control management using security setting

- Upon PLC control using objects like a switch or an input method editor, only the authorized users can perform controls depending on the set security level.
- It supports 10 security levels in total, and the password of a sub-level can be accessed using the password of a main level.
- When the security level is authorized, a session is disconnected after a certain period of time, asking for the password again.

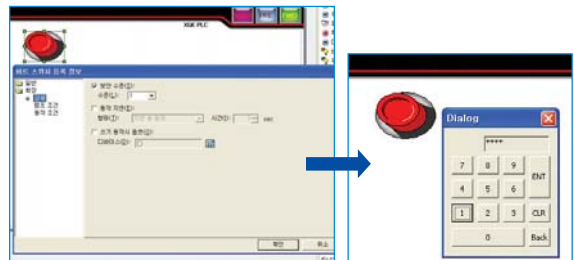

### Free and easy moving of parts

- The fixed values and the parts related to the word device are selected/switched to be displayed on a screen, and the images registered as the given parts can be used.
- A mouse is used to set the movement points for free moves, linear moves, and moves based on the XY coordinates, which can be chosen by users.

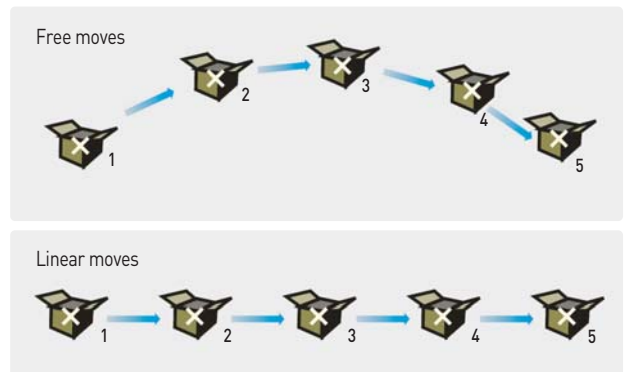



## Automatic registration of a character string table

This function enables the character string input by users in the objects to be automatically registered.

- When the file created using a single language is to be changed to a character string table for the purpose of multi-lingual support, it can be automatically registered to the character string table without inconvenience of users.
- All the static strings used in objects can be registered in the character string table.
- Up to 10,001 character strings can be added to a character string table, and the name of a new character string table and the editing languages can be set and registered by users.

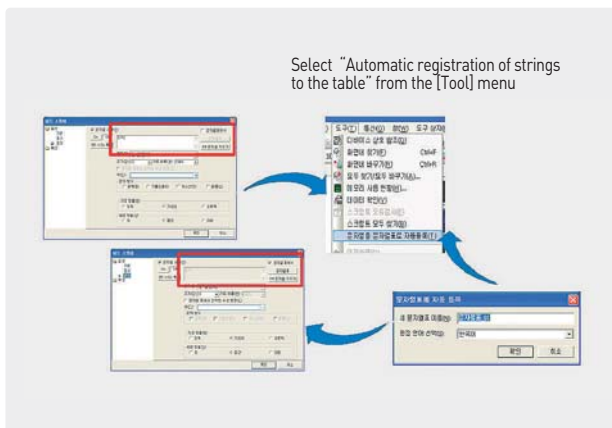

## Memo pad function

Function to create or save a short message by selecting various pen thicknesses and colors on XGT Panel.

- It is useful in exchanging messages between operators working in turns.
- The user chooses the thickness and color of the pen and writes on a screen in order to input the message.
- Such memo can be saved in a CF card or a USB memory, and the data are archived even when the power is turned off.
- Users touch the screen and drag to create a memo.
- When creating a memo, users can UNDO/REDO the memo, the thickness/color of a pen can be changed, and a specific memo or all memos can be deleted.

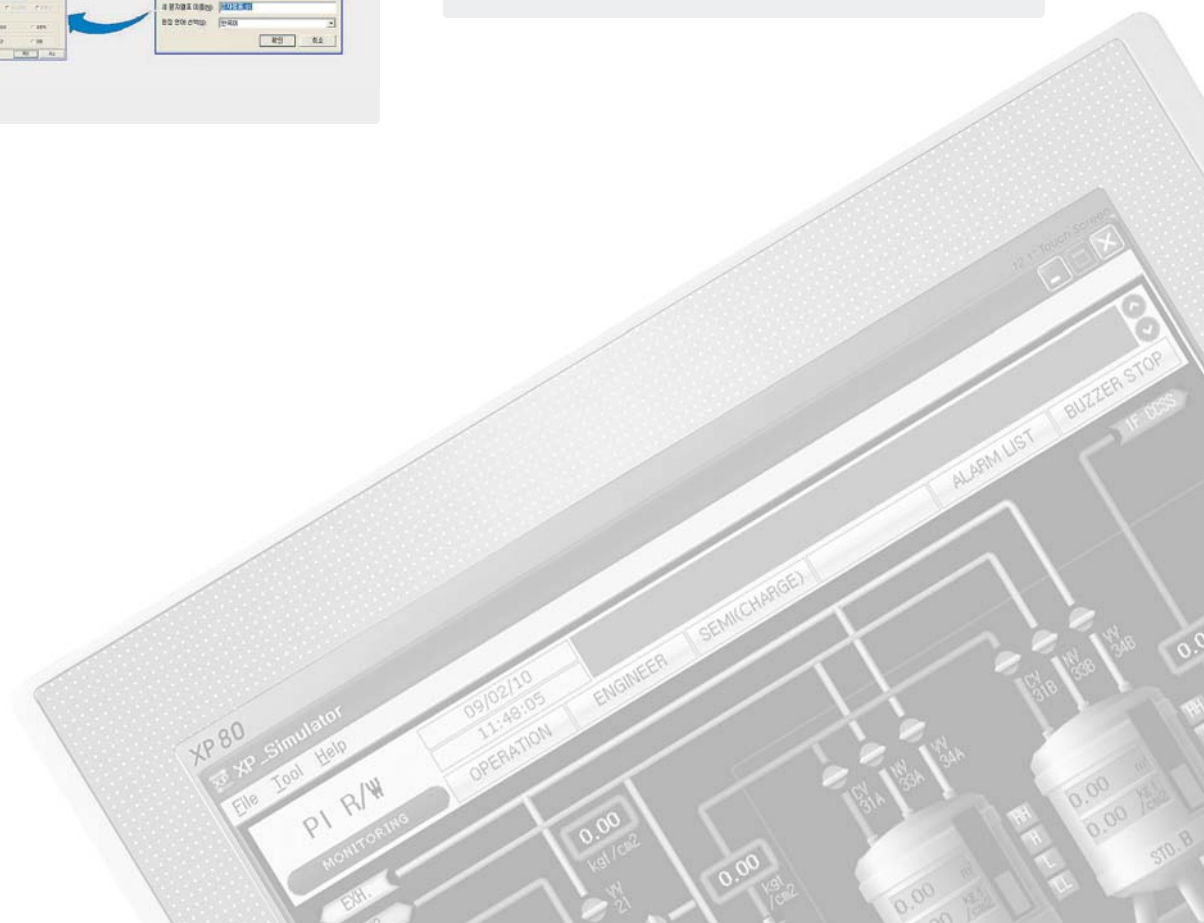
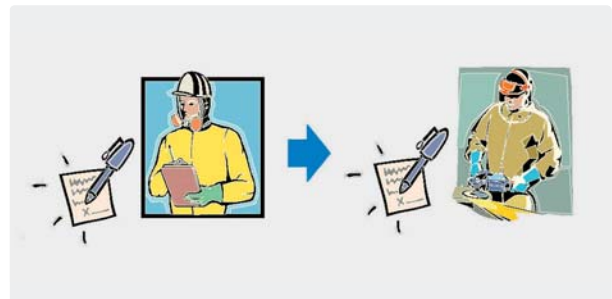

## Advanced Functions

### Alarm Function

- History Alarm**  
 The history of alarms can be saved in the device to check the description of occurrence.  
 The alarm can be categorized into up to 8 upper and 8 lower class groups or an alarm list, and an alarm explorer can display only the group alarms the user may desire. When a screen on description to check the details of alarms generated is registered, the detailed screen window linked to the alarm will appear.  
 (It can be used to check the measures or detailed description when an alarm is generated.)
- Flow Alarm**  
 The alarm generated is displayed on the upper/mid/lower section for users to promptly take actions.  
 Flow alarm can be set to be operable at a specific screen, so it can be used to deliver the information on equipments and company.
- System Alarm**  
 When a serious fault or a trouble of HMI occurs, the system alarm informs the users, which is a critical function.

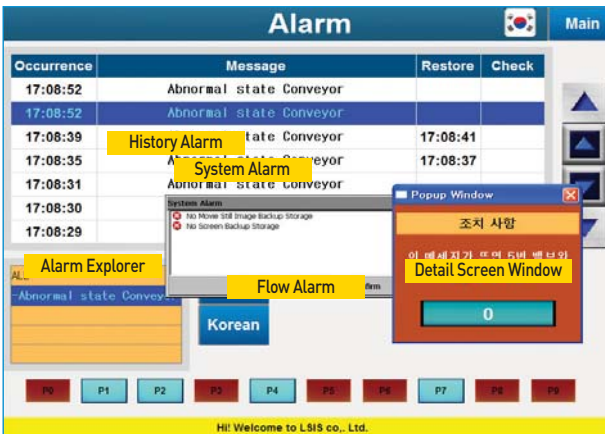

### E-mail Function

- It offers a function to send backup files (.csv) using the E-mail address registered upon backup of the logging and alarm data in XGT Panel.
- The E-mail function for logging can only send the backup files of the group desired for each logging group.
- The E-mail function for history alarm includes a function to send to the E-mail only on the alarm messages to the designated receivers when the user-assigned alarm is generated or recovered.
- The logging and alarm backup files sent can be easily analyzed in PC using a program like EXCEL.

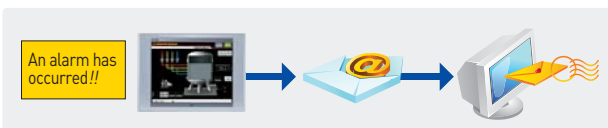

### Logging Function

- It offers a cyclic logging that is repeated depending on the time and device state and a conditional logging which works under the device conditions.
- Up to 32 logging areas (conditions) can be provided, and the maximum size of an area can be set up to 512Kbyte, 100DWord.
- Up to 512Kbyte, 100DWord (64Bit upon bit logging) per logging can be saved.
- Basically, logging is saved in the built-in SRAM(512Kbyte, 100DWord), and the backup of logging is available using the CF card, USB memory stick or USB external hard disk.
- Logging data can be viewed in XGT Panel using a logging view object, and they can be converted into a CSV format to be easily edited using a PC via software such as EXCEL.



### Encryption of Logging/Alarm Backup Files

- The backup file format can be archived as binary files to prevent the data from being damaged or manipulated.
- The encrypted files can be converted into CSV files using a CSV file converter offered from XP-Builder.

### Able to View PDF

- Viewing PDF file XGT Panel
- Saving trouble shooting instructions for failures (alarm) in PDF format so that users could see in the field
- No number limit of PDF files as PDF files are saved in external memories
- This function is available only in iXP series HMIs, not in XP series HMIs

## Scheduler

- Scheduler assigns an operation to be executed on a set time.
- Available functions include Bit ON/OFF, setting Word values and a script operation. Each scheduler can assign up to 8 operations.
- Up to 32 schedulers can be set.



## Recipe

- After the data to be written on PLC are created, the data values created on a PLC device continuously connected to a specific device can be written.
- It can read a lot of device values from the PLC continuously connected to a specific device.
- Basic recipe can register up to 10000 Word/DWord devices and 255 table blocks.
- Recipe data are saved in a non-volatile memory of XGT Panel. Thus, when the power is out, the data saved at the last minute are kept.
- Recipe data can be registered and edited using a XGT Panel or an EXCEL program.

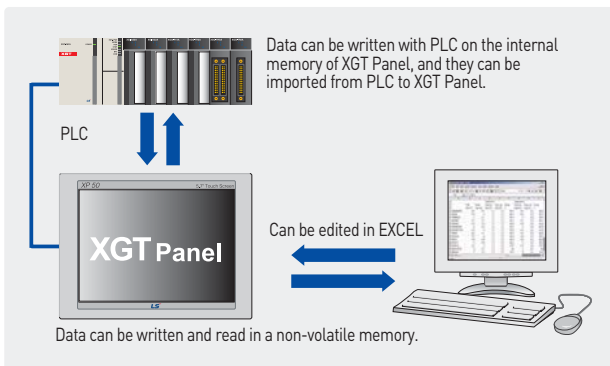

## Script

### Providing a flexible script language

- It is difficult to perform drawing using only the provided object functions, and it can be supplemented using a script.
- A structured language similar to the C language is used for user's convenience.
- The script using complicated arithmetic operations and various functions is executed to greatly reduce the load upon external controllers.
- A validity check of the grammar on the created scripts is available.

### Various uses of scripts

- A wide range of scripts including global scripts, screen scripts and object scripts can be used depending on the usage.
- A global script operates according to ON/OFF of the device assigned, regardless of the screen operation, and a special device can be used for scripts in a regular basis.
- An object script can perform operational management of the object devices.
- A script can run when a screen opens or closes.

### Convenient script tool box & script error check

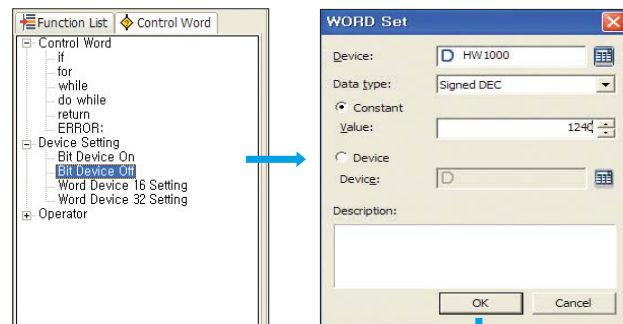

```

1 // Copyright (c) 2004~2006
2 // All rights reserved.
3 // Visit us: http://www.lsis.biz
4
5
6 if(@[W:HW1000] == 1240)
7 {
8     @[W:HW4000] = 5;
9     @[X:Hx0000] = false;
10 }
11 else
12 {
13     @[X:Hx00037] = false;
14     @[X:Hx00020] = true;
15 }
16
17 ERROR:
18 {
19 }
20
21
    
```





## Link with Controllers

### Convenient Simulator

#### Offline simulation

- Without XGT Panel, the drawing data can be directly viewed from PC.
- Devices can be monitored using a PC, and values can be directly input to check operations.
- A simulator is used to check the operations just like the XGT Panel. Before transmitting the drawing data to HMI, data errors and abnormal operations can be checked.



### Able to Link with PLC Simulator

- Controlling and monitoring testing in PC linking XP-Builder (XP-Simulator) and PLC simulator
- Linking with LSIS PLC simulator and XG5000 simulator
- Linking with SIEMENS PLC simulator and S7-PLCSIM (S7-PLCSIM v5.4 or above)
- Linking with Rockwell Automation PLC simulator and RSLogix Emulate 5000 Controller (v21.00.00 or above)
- Linking with Mitsubishi PLC simulator and GX Simulator (GX Simulator v7.30 or above)

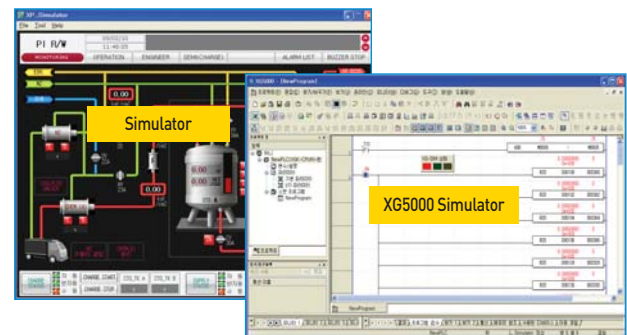

### Path-through (XP-VSP)

When XGT Panel is connected to PLC with serial, PLC ladder program can be modified using the internal Ethernet.

- Users no longer have to change the cable for PLC program modification, or to go to the PLC for changes.
- A program can be modified even when a control panel is far away.

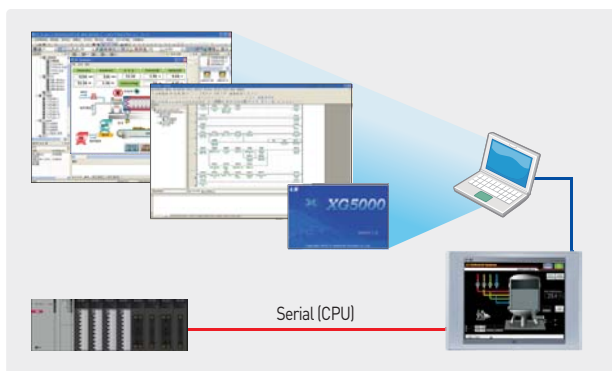

Note) XP-VSP user manual reference

Manufacturers	Supported Drives
LSIS	ALL LSIS PLC CPU XGI/K Series Link (Only Remote-1 Connection)
Omron Corporation	CS/CJ Host Link Serial
YASKAWA	MEMOBUS RTU Master

### Using XGT PLC for batch-registration of devices (tag function)

The variable names used in the PLC program that is created using XG5000 are automatically registered in XP-Builder, so that they can be used in drawings.

- [Save as a Variable/Description File] of XG5000 is used to first save the variable names used as CSV files.
  - Using [Import XG5000 Symbols] from the [Tag] item of XP-Builder, an automatic registration via tags is possible (Array variables supported).
- Without changing the memory address, the variables used in the PLC program can be used.

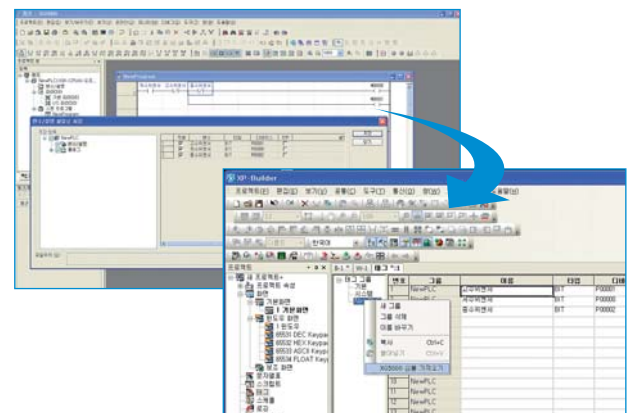

## Communication Options

### Fieldbus option provided

Various Fieldbus communications using the XGT Panel options

(RAPIenet, Profibus-DP and CANopen Slave offered)

### RAPIenet(XPO-EIMT) twisted-pair ring system diagram

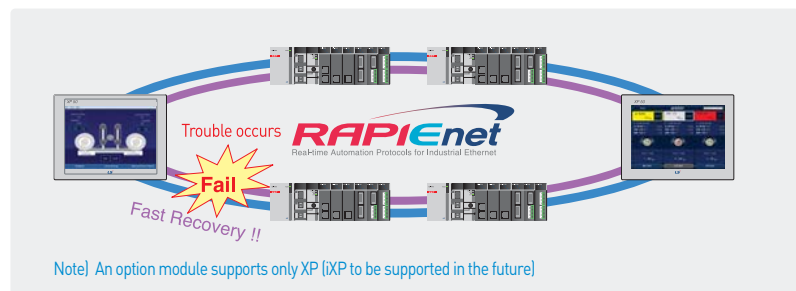

## XP-Server Function

The data required from the production site's XGT Panel can be directly collected or saved in a PC. It has several roles including a mutual data exchange between several XGT Panels, or sending an E-mail or connecting to a Database.

- It connects to the Database via PC to save, inquire and manage the XGT Panel data.
- When a trigger condition is generated, users will be informed via data E-mail of PC.
- When a trigger condition is generated, it imports or writes the screen capture, logging, alarm and recipe data of a specific XGT Panel.
- It is possible to collect various information including production outputs and causes of errors and failures from the XGT Panel to the DB server

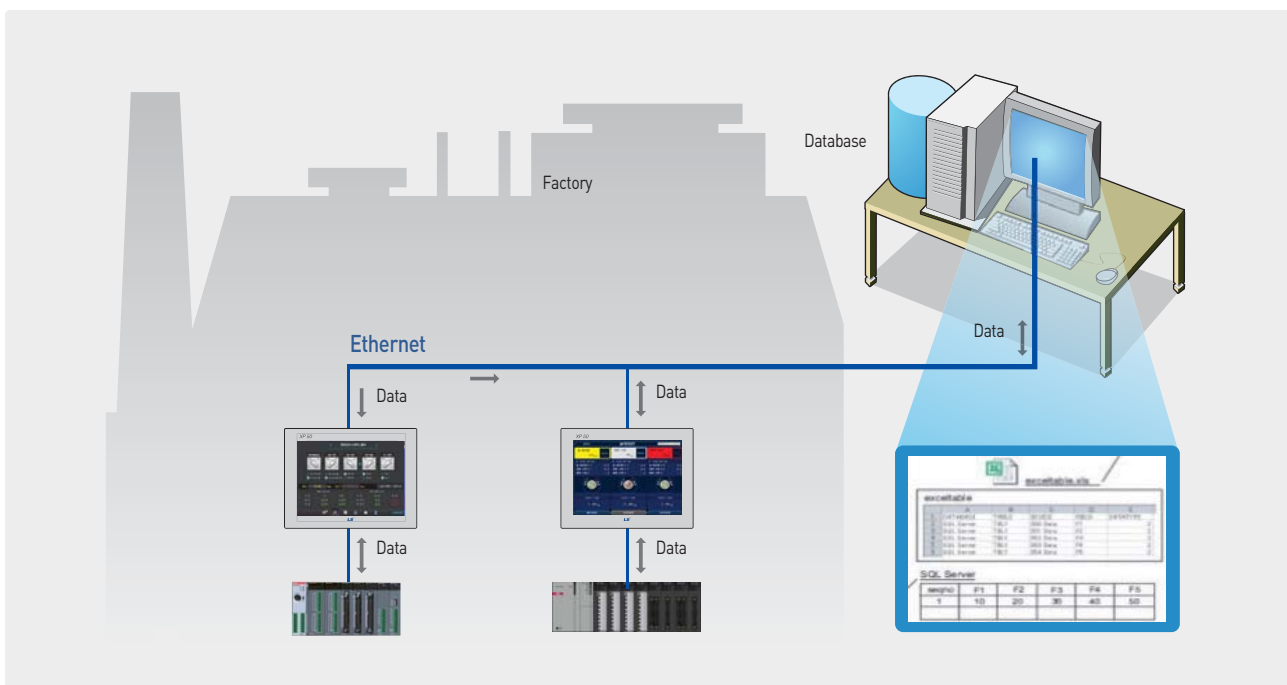

## External Monitoring Function

※ Only the Ethernet-support models can use the function.

### XP-Remote

- An XGT Panel screen can be monitored and controlled remotely with a PC.
- Up to 4 PCs can remote-access to a single XGT Panel. (Only one PC can access XP-VNC.)
- Remote PC control of XGT Panels can be authorized or restricted (When not authorized, it is impossible to control with the Remote PC).
- There is a synchronization mode and a non-synchronization mode, which allows users to monitor the XGT Panel and the Remote PC screen under the same or different conditions.

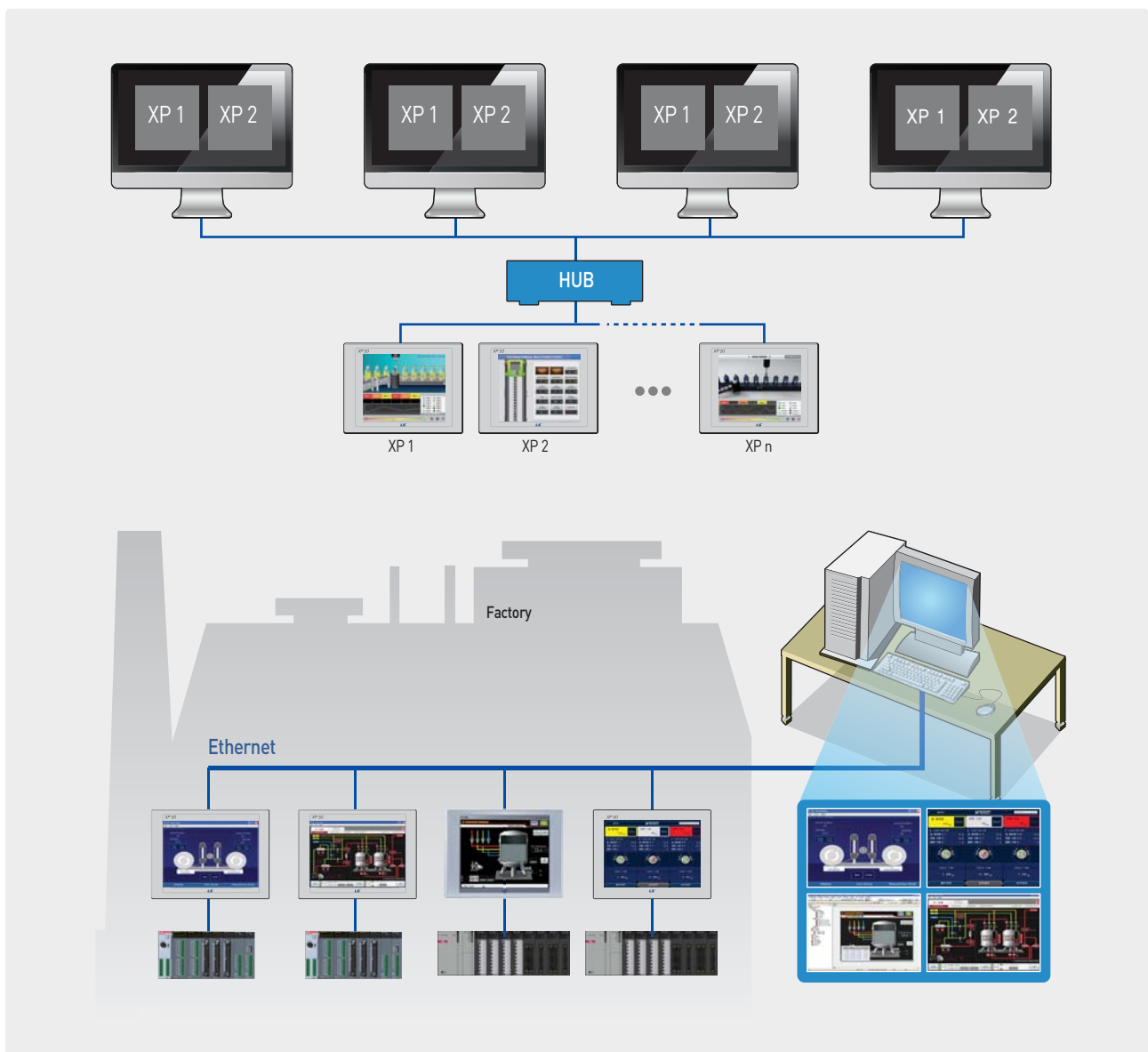



## Web Server

- The screen currently viewed on a XGT Panel can be viewed on a web browser via Internet.
- It is accessible in any place where Internet is connected.
- It can be connected to multiple Internet Explorers. (Impossible to access the XP screen at the same time)
- It is possible to upload the logging and alarm backup files as csv files in the XGT Panel.
- It is possible to restrict access of specific users or groups.

※ The functions described above are available when a Web Server Program is installed to the XGT Panel using XP-Manager.

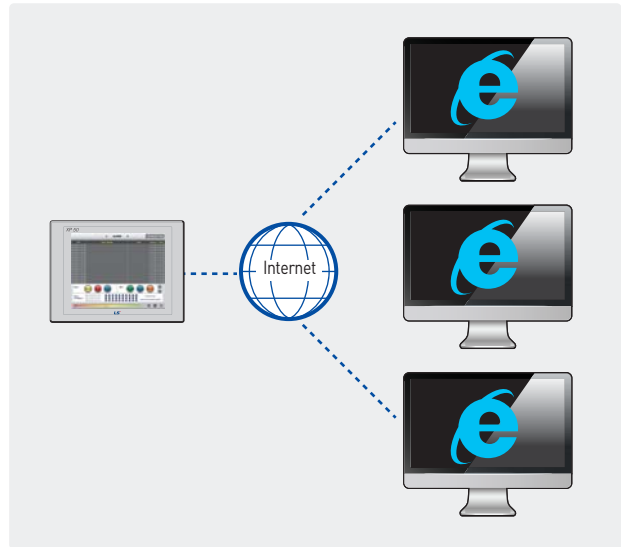

## XP-VNC

- The screen currently shown in the XGT Panel can be viewed from the user's PC.
- Several XGT Panels can be monitored and controlled with one PC.
- After inserting the IP of XGT Panel to be accessed from XP-VNC (S/W for PC), the current screen of the XGT Panel can be monitored and controlled.
- It is possible to restrict PC control when the XGT Panel is under operation on site (VNC interlock device provided).

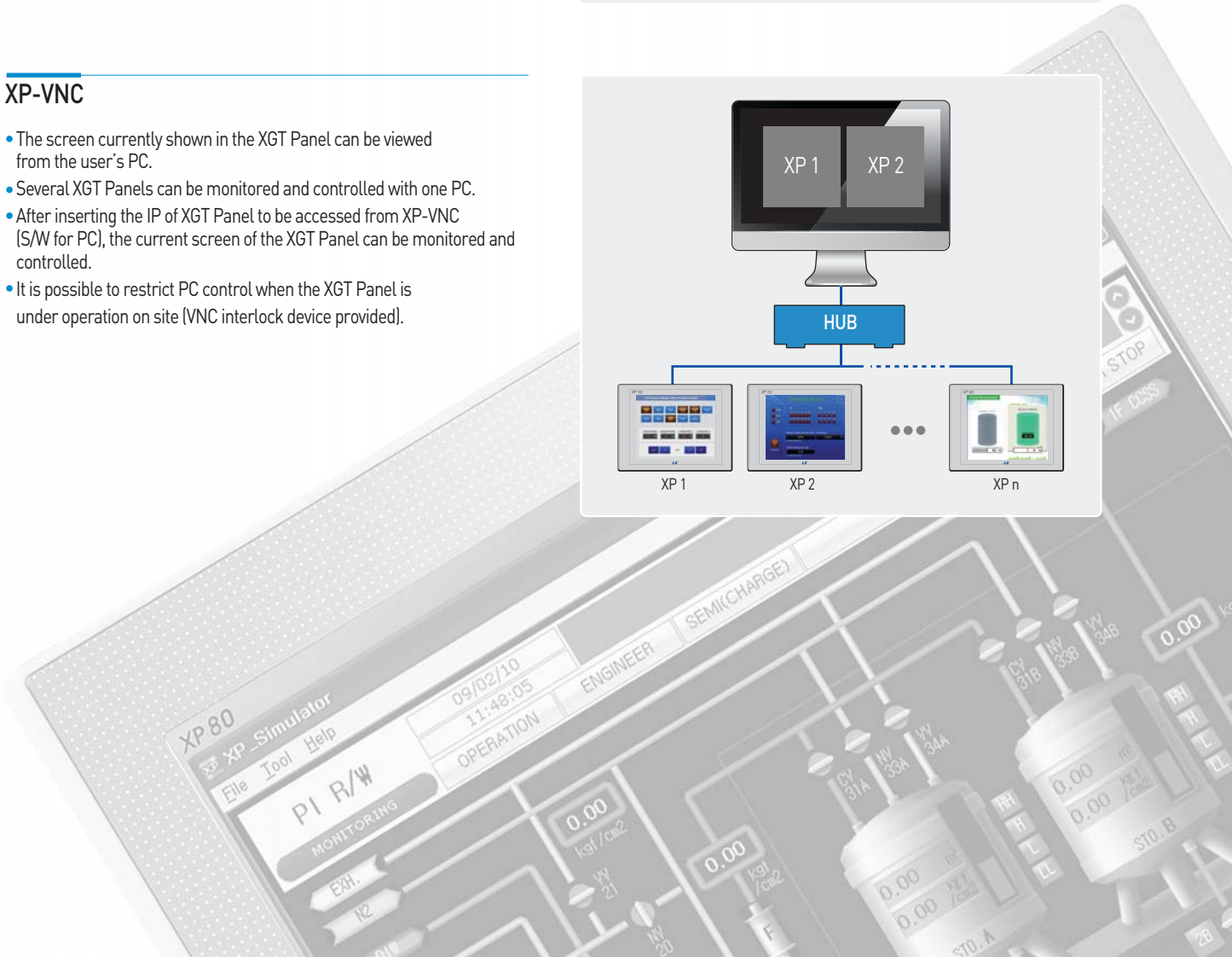
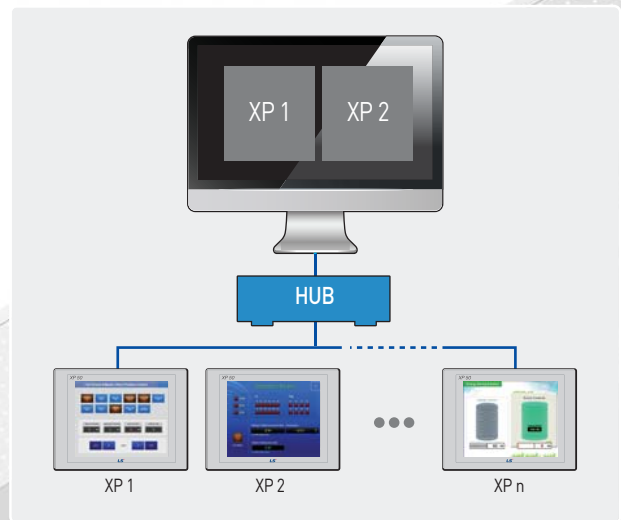



# Feature

## System Block Diagram

### 1 : 1 Serial/Ethernet Communication

One controller to one XGT Panel

- ※ In case of the 1:1 Ethernet communication, a cross cable should be used.

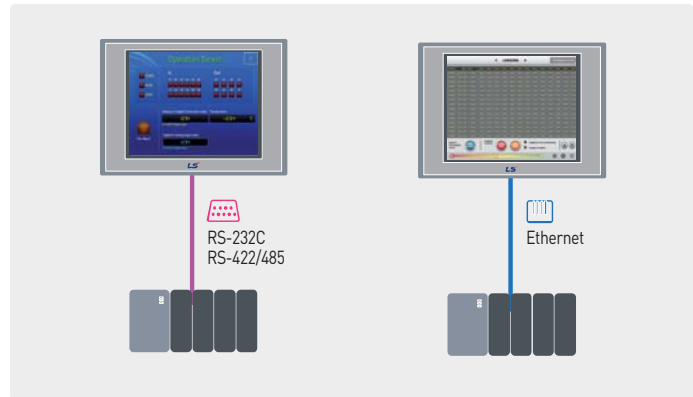

### N : 1 Serial Communication

One controller to multiple XGT Panels (serial)

- ※ Up to 16 XGT Panels can be connected, but the speed for screen refreshing varies according to the number of panels.
- ※ Connection available only to specific controllers (limited to PLCs)

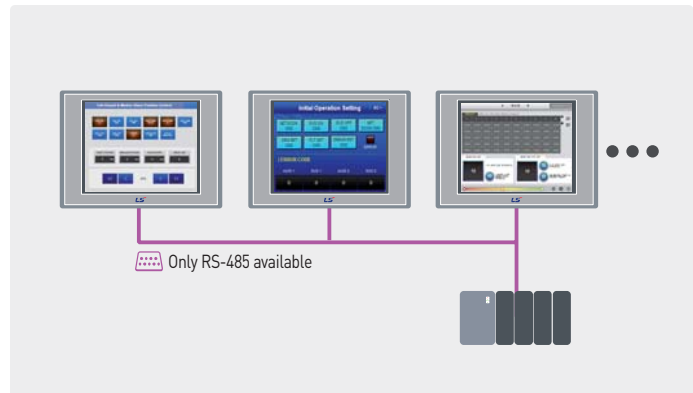

### Simultaneous connection with multiple controllers

4 kinds of controllers to one XGT Panel

- ※ Without the RS-422/485 and RS-232C, up to 4 controllers can be connected using only Ethernet.
- ※ When it comes to iXP, up to 16 controllers can be connected.

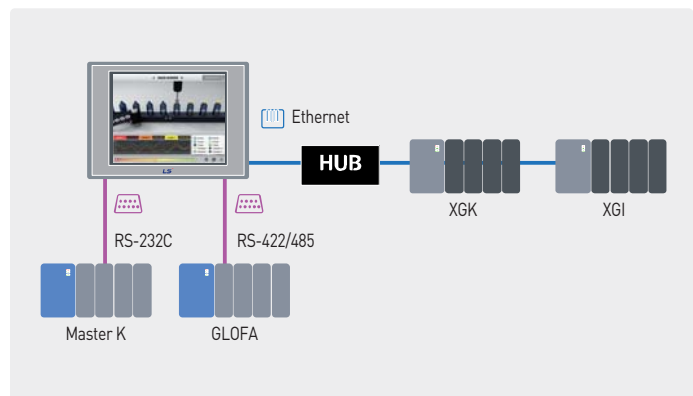

### 1 : N Serial Communication (Multi Drop)

Multiple controllers to one XGT Panel

- ※ When 1:N communication is applied, the same types of controllers should be used.

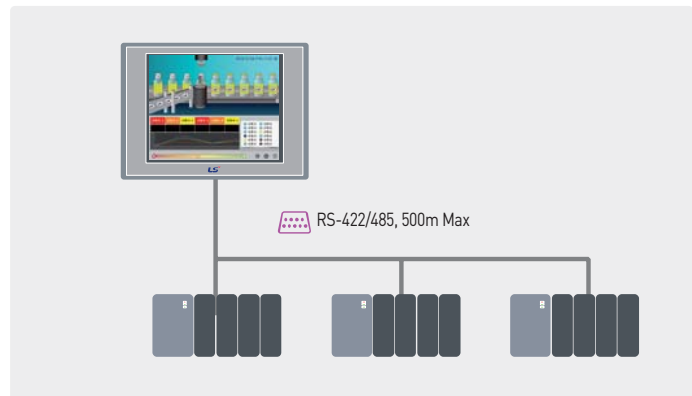

### N:1 Ethernet Communication

One controller to multiple XGT Panels (Ethernet)

- ※ According to the controller type, the number of XGT Panels connected may vary.

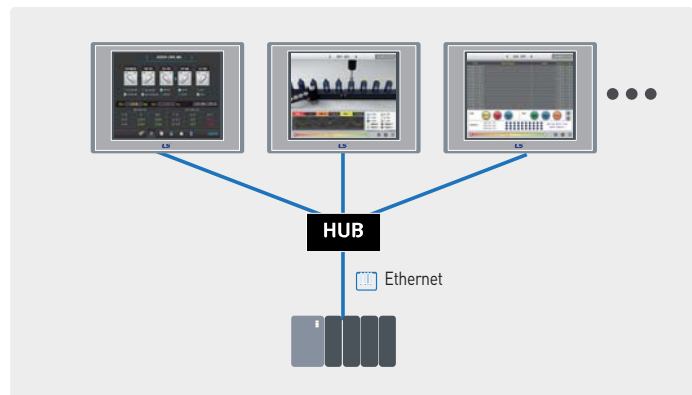

### N:M Ethernet Communication

Multiple controllers to multiple XGT Panels

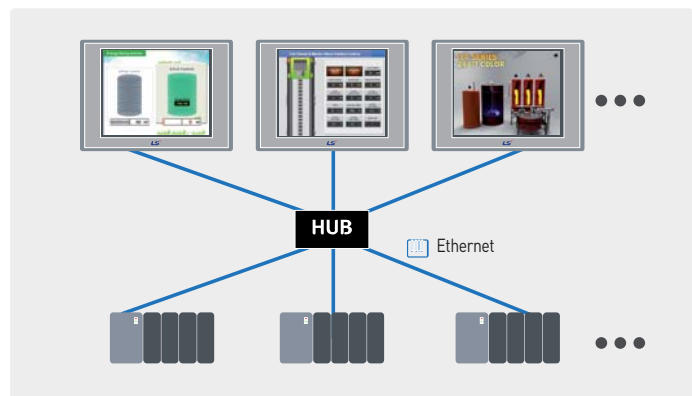



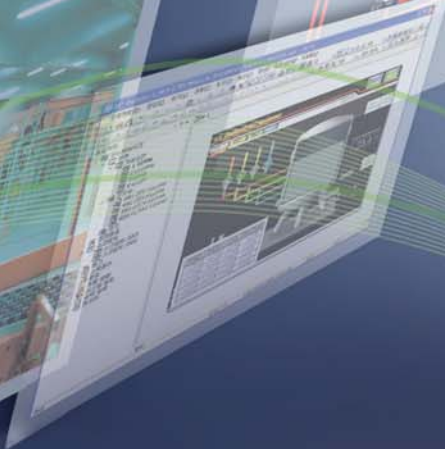
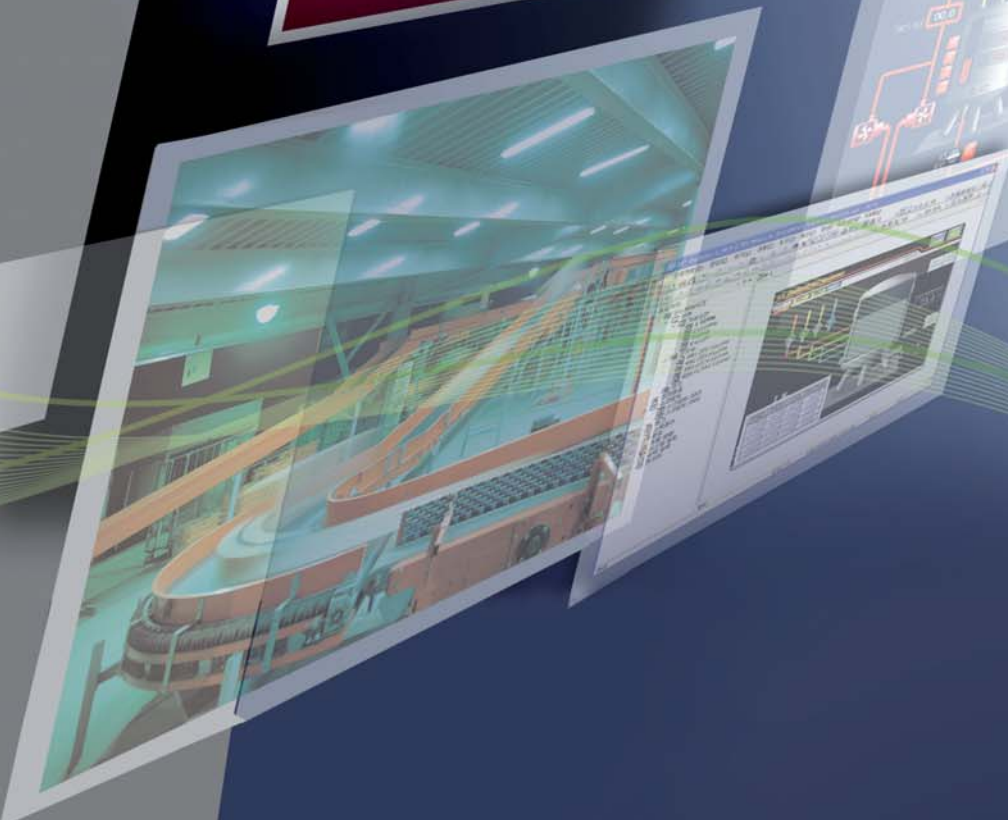

# Our Solution

**We are leaping as a global leader beyond the top enterprise in Korea in the field of automation solutions.**

The LSIS HMI solutions incorporate the core H/W and S/W technologies and services, which are optimized for client's environments at various industrial sites, ranging from unit machines to massive process control.

# iXP Series

### High-resolution and performance

- 1GHz high-performing CPU & quick screen refreshing speed
- 16,777,216. TFT color (24bit) support & high-luminance/resolution LCD
- Mass internal memory (User memory: 128MB, Data backup: 1MB)

### User-oriented simple environment

- Various storage interfaces (USB/SD)
- Movement detection (presence sensor) system (within 1m)



## Dimensions

[Unit: mm]

iXP50-TTA

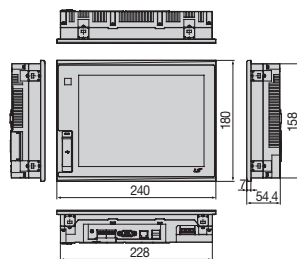

iXP70-TTA

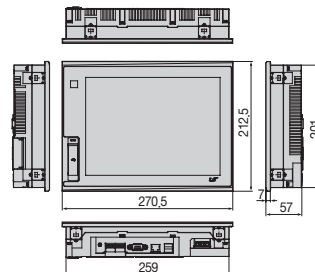

iXP80-TTA

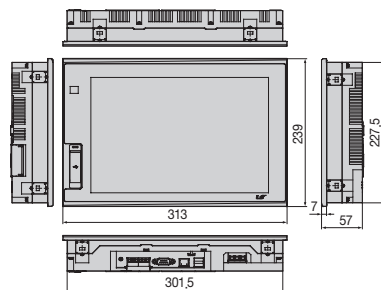

iXP90-TTA

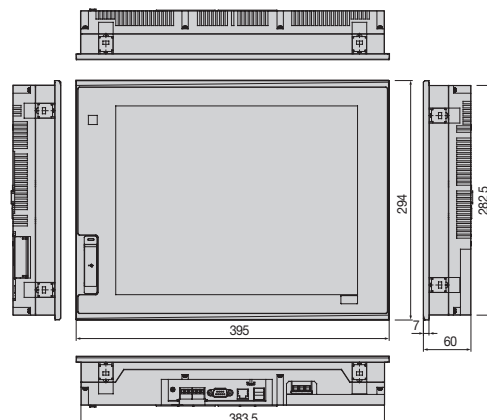



## General Information

Item	Description	Standard				
Ambient Temperature	0°C~+50°C					
Storage Temperature	-20°C~+60°C					
Ambient Humidity	10~85%RH, without dew condensation					
Storage Humidity	10~85%RH, without dew condensation					
Vibration resistance	Occasional vibration		Counts	10 times each direction (X, Y and Z)	IEC 61131-2	
	Frequency	Acceleration				Amplitude
	5 ≤ f < 9Hz	-				3.5mm
	9 ≤ f ≤ 150Hz	9.8%				-
	Continuous vibration					
	Frequency	Acceleration				Amplitude
5 ≤ f < 9Hz	-	1.75mm				
9 ≤ f ≤ 150Hz	4.9%	-				
Shock resistance	Maximum shock acceleration: 147%(15g) * Authorization time: 11ms * Pulse waveform: Half-sine wave (3 times each of X, Y and Z) *			IEC 61131-2		
Vibration resistance	Square wave impulse noise	DC: ±1,200V AC: ±1,800V		LSIS Standards		
	Electrostatic discharge	±4kV (Contact discharge)		IEC 61131-2, IEC 61000-4-2		
	Radiated electromagnetic field noise	80 ~ 100MHz, 10V/m		IEC 61131-2, IEC 61000-4-3		
	Fast transient/Burst noise	Power Module: 2 kV, Communication Interface: 1kV		IEC 61131-2, IEC 61000-4-4		
Operating ambience	Free from corrosive gas and excessive dust					
Altitude	2,000m (6,562ft) or below					
Pollution degree	2 or under					
Cooling method	Natural air-cooling					

## Specifications

Item	iXP50-TTA/DC	iXP70-TTA/DC iXP70-TTA/AC	iXP80-TTA/DC iXP80-TTA/AC	iXP90-TTA/DC iXP90-TTA/AC
Display type	TFT LCD			
Screen size	21.3cm (8.4")	26.4cm (10.4")	30.7cm (12.1")	38.1cm (15")
Display Resolution	800 × 600 pixel (SVGA)	800 × 600 pixel (SVGA)	800 × 600 pixel (SVGA)	1,024 × 768 pixel (SVGA)
Color indication	16-bit and 24-bit Color (default: 16-bit Color)			
Indication degree	Left/Right: 80 deg. Up: 80 deg. Down: 60 deg.	Left/Right: 80 deg. Up: 60 deg. Down: 80 deg.		
Backlight	LED Type			
Backlight duration	70,000 hours	60,000 hours		
Brightness	500 cd/m <sup>2</sup>	700 cd/m <sup>2</sup>	550 cd/m <sup>2</sup>	800 cd/m <sup>2</sup>
Touch panel	4-Line type, analog			
Sound Output	Magnetic buzzer (85dB)			
Process	ARM Cortex-A8 Core (32bit RISC), 1GHz			
Memory	Flash	512MB(display 128MB)	1GB(display 128MB)	
	Operating RAM	256MB	512MB	
	Backup RAM	1MB		
Backup data	Date/Hour data, Logging/Alarm/Recipe data and nonvolatile device			
Battery duration	Approx. 3 years (Operating ambient temperature of 25° ...)			
Ethernet	1 channel, 10/100BASE-TX			
USB Host	3 channels, USB 2.0 host (mouse, keyboard, printer* and USB memory driver is available) 1 channel, USB 2.0 slave (for download and upload project file)			
RS-232C	1 channel			
RS-422/485	1 channel, RS-422/485 mode			
SD Card	1 Slot (SDHC)			
Human sensor	-	Detection range: side 1-1.5m, front 40-50cm Angle: high/low 100°, left/right 140° (detecting 5-20 micron infrared light)		
Audio output	LINE-OUT 1 channel			
Expansion module	For communication and I/O option module (available later)			
VM module	-	4 channels video input (available later)		
Multi-language	Up to 12 language simultaneously			
Animation	GIF format is available			
Recipe	available			
Data logging	available			
Script executor	available			
Certifications	CE, UL(cUL), KC			
Protection standard	IP65			
Dimension (mm)	240.5 × 180.0 × 54.4	270.5 × 212.5 × 60.0	313.0 × 239.0 × 56.0	395.0 × 294.0 × 60.0
Panel cut (mm)	228.5 × 158.5	259.0 × 201.0	301.5 × 227.5	383.5 × 282.5
Rated voltage	DC24V	DC12/24V(AC 100-240V)		
Power consumption (W)	30.8	42.3	42.3	42.3
Weight(Kg)	1.9	2.2	2.4	3.9

\* SEW00 printer only

# eXP Series

- TFT LCD-applied wide type
- LED Backlight adopted for enhanced contrast ratio and low-power
- PLC Ladder monitoring function:  
Only XGK/XBC supports\*
- Web Server\* / Data Server\* /  
Path-Through Function\*
- Remote Viewer Function\*
- Screen editor : XP-Builder

\*Functions that support only the TTA model



## Dimensions

eXP40-TTA

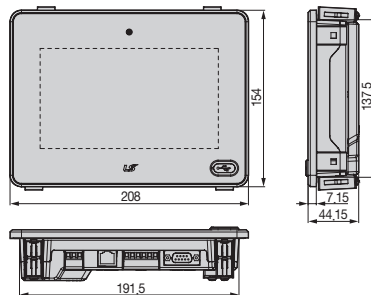

eXP40-TTE

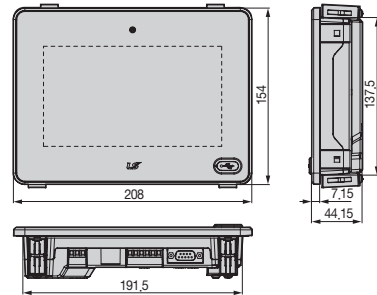

[Unit: mm]

eXP60-TTA

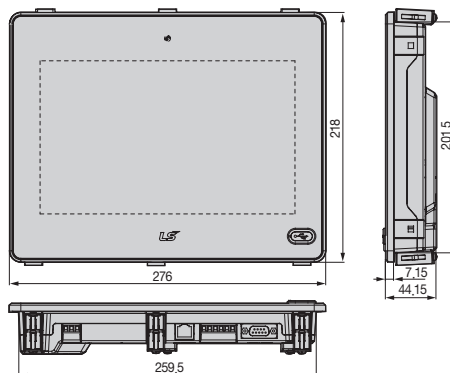

## General Information

Item	Description	Standard		
Ambient temperature	0°C~+50°C			
Storage temperature	-20°C~+60°C			
Ambient humidity	10~85%RH, without dew condensation			
Storage humidity	10~85%RH, without dew condensation			
Vibration resistance	Occasional Vibration			
	Frequency	Acceleration	Amplitude	
	5 ≤ f < 9Hz	-	3.5mm	
	9 ≤ f ≤ 150Hz	9.8%	-	
	Continuous Vibration		10 times each direction (X, Y and Z)	
	Frequency	Acceleration		Amplitude
	5 ≤ f < 9Hz	-		1.75mm
	9 ≤ f ≤ 150Hz	4.9%	-	
Shock resistance	Maximum shock acceleration: 147%(15g) Authorization time: 11ms Pulse waveform: Half-sine wave pulse (3 times each of X,Y and Z)	IEC 61131-2		
Noise resistance	Square wave impulse noise	DC: ±1,200V	LSIS Standards	
	Electrostatic discharge	±4kV (Contact discharge)	IEC 61131-2, IEC 61000-4-2	
	Radiated electromagnetic field noise	80 ~ 100MHz, 10V/m	IEC 61131-2, IEC 61000-4-3	
	Fast transient/Burst noise	Power module: 2.4 kV, Communication interface: 1.2kV	IEC 61131-2, IEC 61000-4-4	
Operating ambience	Free from corrosive gas and excessive dust			
Altitude	2,000m (6,562ft) or below			
Pollution degree	2 or under			
Cooling method	Natural air-cooling			

## Specifications

Item	eXP40-TTE/DC	eXP40-TTA/DC	eXP60-TTA/DC
Display Type	TFT color LCD		
Display Size	17.7cm (7 inch)		25.9cm (10.2 inch)
Resolution	800 x 480 (WVGA)		
Color	65,536 colors		
Display Angle	Left/Right: 60 deg. Up: 40 deg. Down: 60 deg.		Left/Right: 55 deg. Up: 35 deg. Down: 55 deg.
Backlight	LED mode, Auto On/Off		
Backlight Capacity	20,000 hr		
Brightness	230 cd/m <sup>2</sup>		200 cd/m <sup>2</sup>
Touch Panel	4-wire system, Analogue		
Sound	Magnetic buzzer (85dB)		
Processor	ARM9 Core (32bit RISC), 454MHz		
Memory	Flash	128MB(Screen 64MB)	
	Operation RAM	128MB	
	Backup RAM	128KB	
Backup Type	Date/Time data, Logging/Alarm/Recipe data, non-volatile device		
Batter Capacity	Around 3 years (Upon operation at 25°C)		
Ethernet	-	1 channel, 10/100BASE-TX	
USB Port	1 channels, USB 2.0 host (mouse, keyboard, printer * and USB memory driver is available)		
	1 channel, USB 2.0 slave (for download and upload project file)		
RS-232C	1 channel		
RS-485	1 channel		
RS-422/485	1 channel, 422/485 Combination		
Multi-language	Up to 12 language simultaneously		
Animation	GIF format is available		
Recipe	available		
Data logging	available		
Script executor	available		
Certification	CE, UL(cUL), KC		
Protection	IP65		
Size (mm)	208.0 × 154.0 × 44.0		276.0 × 218.0 × 44.2
Panel Cut (mm)	192.0 × 138.0		260.0 × 202.0
Power	DC24V		
Power Consumption (W)	23.1	23.1	23.1
Weight (kg)	0.59	0.60	1.0

\* SEWOO printer only

# XP Series

- 65,536 TFT color
- 4/10/20MB User memory, 128/512KB Backup memory
- Ethernet & serial communications support
- USB Host function to be used in various PC devices
- Up to 12 languages at a time and a batch-change of languages
- Offline simulations  
(Link to the XG5000 simulator)



## Dimensions

[Unit: mm]

XP30-TTA/TTE

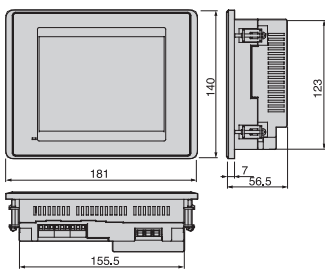

XP40-TTA/TTE (7" wide Type)

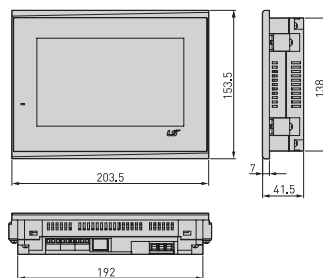

XP50-TTA

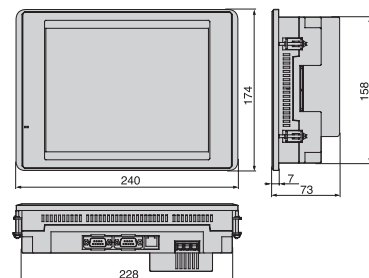

XP70-TTA

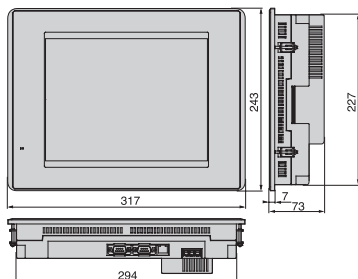

XP80-TTA

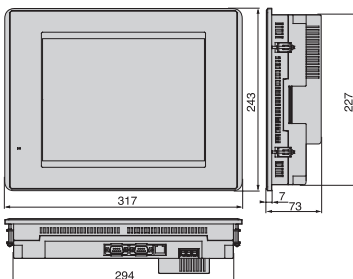

XP90-TTA

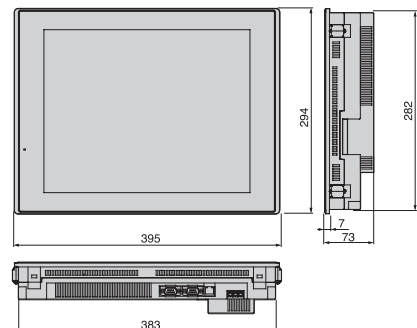



## General Information

No.	Item	Description	Standard		
1	Ambient temperature	0°C~+50°C			
2	Storage temperature	-20°C~+60°C			
3	Ambient humidity	10~85%RH, without dew condensation			
4	Storage humidity	10~85%RH, without dew condensation			
5	Vibration Resistance	-20°C~+60°C	Counts  10 times each direction (X, Y and Z)  IEC 61131-2		
		Frequency		Acceleration	Amplitude
		5 ≤ f < 9Hz		-	3.5mm
		9 ≤ f ≤ 150Hz		9.8%	-
		Continuous Vibration			
		Frequency		Acceleration	Amplitude
5 ≤ f < 9Hz	-	1.75mm			
9 ≤ f ≤ 150Hz	4.9%	-			
6	Shock Resistance	Maximum shock acceleration: 147%g(15g) Authorization time: 11ms Pulse waveform: Half-sine wave pulse (3 times each of X,Y and Z)	IEC 61131-2		
7	Noise Resistance	Square wave impulse noise	AC: ±1,500V DC: ±1,000V LSIS Standards		
		Electrostatic discharge	Voltage: 6 kV (Contact discharge) IEC 61131-2, IEC 61000-4-2		
		Radiated electromagnetic field noise	27 ~ 500MHz, 10V/m IEC 61131-2, IEC 61000-4-3		
		Fast transient/Burst noise	Power module: 2 kV, Communication interface: 1kV IEC 61131-2, IEC 61000-4-4		
8	Operating ambience	Free from corrosive gas and excessive dust			
9	Altitude	2,000m (6,562ft) or below			
10	Pollution degree	2 or under			
11	Cooling method	Natural air-cooling			

## Specifications

Model Type	XP30-BTE/DC	XP30-BTA/DC	XP30-TTE/DC	XP30-TTA/DC	XP40-TTE/DC	XP40-TTA/DC	XP50-TTA/DC	XP70-TTA/AC XP70-TTA/DC	XP80-TTA/AC XP80-TTA/DC	XP90-TTA/AC	
	Mono			Color							
Display Element	Mono Blue LCD			TFT color LCD							
Screen Size	14cm [5.7"]			17.7cm [7"]		21cm [8.4"]	26cm [10.4"]	31cm [12.1"]	38cm [15"]		
Resolution	320×240			800×480		640×480	800×600	1024×768			
Color	8-column Gray Scale	256 colors	65,536 colors		65,536 colors						
Backlight	LED mode					CCFL(can be replaced), Auto On/Off					
	50,000 hours		60,000 hours	30,000 hours		50,000 hours			60,000 hours		
Contrast	Adjustable			Fixed							
Brightness	230cd/m <sup>2</sup>			600cd/m <sup>2</sup>	280cd/m <sup>2</sup>	480cd/m <sup>2</sup>	430cd/m <sup>2</sup>	400cd/m <sup>2</sup>	450cd/m <sup>2</sup>		
Viewing Angle	Up/Down(Degree)	20/40	80/80	70/70	50/60	50/60	45/65	45/75	60/50		
	Left/Right(Degree)	45/45		80/80	65/65	65/65	65/65	65/65	75/75		
Touch Panel	4-wire system, analogue				Analog resistive		8-wire system, analogue				
Movement LED	Green: Normal RUN (Monitoring & drawing data download) Red: Error (Communication error & drawing data error)										
Memory	Screen Data	4MB	10MB	4MB	10MB	4MB	10MB	10MB	20MB		
	Backup Data	128KB	512KB	128KB	512KB	128KB	512KB	512KB			
Ethernet	-	1ch, 10/100Base-T	-	1ch, 10/100Base-T	-	1ch, 10/100Base-T					
USB Interface	USB Host X 1	USB Host X 2	USB Host X 1	USB Host X 2	USB Host X 1		USB Host X 2				
Serial	2ch(1 port for PC communication)										
	1ch, 422/485 optional mode										
CF Card Interface	-	CF card (TAPE-1)×1	-	CF card (TAPE-1)×1	-	CF card (TAPE-1)×1					
AUX Interface	-	Optional	-	Optional	-	Optional					
Certification	CE, UL, KC										
Protection	IP65 (Front Water Proof Structure)										
Size(W×H×D)mm	181 x 140 x 56.5	181 x 140 x 66.5	181 x 140 x 56.5	181 x 140 x 66.5	203.5 x 153.5 x 41.5		240 x 174 x 73	317 x 243 x 73	395 x 294 x 73		
Panel Cut (W×H)mm	155.0 × 123.5				192 x 138		228.5 x 158.5	294.5 x 227.5	383.5 x 282.5		
Weight (kg)	0.62	0.75	0.62	0.75	2.2	2.4	1.4	2.2	2.4	3.9	
Power	Rated Voltage										
	DC 24V										
	Permitted Voltage	AC	-								
		DC	MIN 19.2 VDC, MAX 28.8 VDC								
Power Consumption [W]	AC	-	-	-	-	-	21.8	31.9	31.9		
	DC	9.7	16.9	9.6	17.4	9.8	9.8	18.7	20.1	25.7	



## List of Communication Drivers

Manufacturer	Driver name
LSIS	GM CPU
	GM Cnet
	GM Enet
	MK CPU
	MK Cnet
	MK Enet
	XGK CPU
	XGK Cnet
	XGK Enet
	XGK EtherNet/IP
	XGB CPU
	XGB Cnet
	XGB Enet
	XGB EtherNet/IP
	XGI/XGR CPU
	XGI/XGR Cnet
	XGI/XGR Enet
	XGI/XGR EtherNet/IP
	XEC CPU
	XEC Cnet
XEC Enet	
XEC EtherNet/IP	
Inverter LSBus	
Inverter Modbus	
User Defined Protocol	
User Defined Protocol (Slave)	
XGT Servo	
LS Mecapion	VS/VP Servo Drive
	MXQ Series
BACnet	IP Master
BYD Auto	BYD Auto dedicated
CAN in Automation	CANopen Slave
Control Techniques	CT Modbus RTU
DAEWON GSI	DAEWON GSI dedicated controller
Dasarobot	iM-SIGMA series
Delta Electronics	DVP Series
Digital Electronics(Pro-face)	Memory Link
Fuji Electric Systems	MICREX-SX Series SIO
	MICREX-SX Ethernet
GE Intelligent Platforms	SNP
	SNP-X
HANYOUNG NUX	Temperature Controller
HIGEN Motors	Servo
Hitachi	H Series Ethernet
	H Series Link
HYUNDAI Elevator	SKY-RAV(Ethernet)
	SKY-RAV(Link)
KDT Systems	CIMON Serial Link
	BP Series Loader
	CP Series Loader
	XP Series Loader
KEYENCE	KV-700/1000/3000/5000/5500 Serial
	KV-700/1000/3000/5000/5500 Ethernet

Manufacturer	Driver name
KOYO Electronic	DirectNet
KTURBO	Turbo Blower
Lenze Automation	Lecom A/B
Mitsubishi Electric	MELSEC A-CPU
	MELSEC A-Link
	MELSEC FX-CPU
	MELSEC FX-Ethernet
	MELSEC FX-Link
	MELSEC Q-CPU, "U" Type excluded
	MELSEC QnA-Link
	MELSEC QnA-Ethernet
	MELSEC QnU CPU Ethernet
	MELSERVO-J2
MELSERVO-J3	
OMRON	CS/CJ Series Ethernet
	CS/CJ Host Link
	C Series Host Link
	CS1 EthernNet/IP
	CJ2 EthernNet/IP
Panasonic Electric	FP Series
	MINAS Servo
Parker	Hi-Drive
PROFIBUS International	PROFIBUS DP Slave
Rockwell Automation	Compact/ControlLogix EtherNet/IP
	MicroLogix EtherNet/IP
	SLC500 Series DF1
	Compact/ControlLogix DF1
	MicroLogix DF1
RS Automation	N/NX-CCU
	NX-CCU+
Schneider Electric	MODBUS RTU Master
	MODBUS RTU Slave
	MODBUS TCP Master
	MODBUS TCP Slave
	MODBUS ASCII Master
	MODBUS ASCII Slave
SEW EURODRIVE	MOVIDRIVE Serial
Siemens AG	S7 3964(R)/RK512
	S7 MPI(Adapter)
	S7 PPI
	LOGO Ethernet
	S7 1200 Ethernet
	S7 300/400 Ethernet
Sprint Electric	DC Motor Drive Ethernet
YASKAWA Electric	MEMOBUS RTU Master
	MP Series Ethernet (Extension)
YOKOKAWA Electric	FA-M3 Series
	FA-M3 Series-Ethernet
Beckhoff	ADS Ethernet
TSSI	VERID+ FingerPrint Reader
FATEC Automation Corporation	FB Series Serial

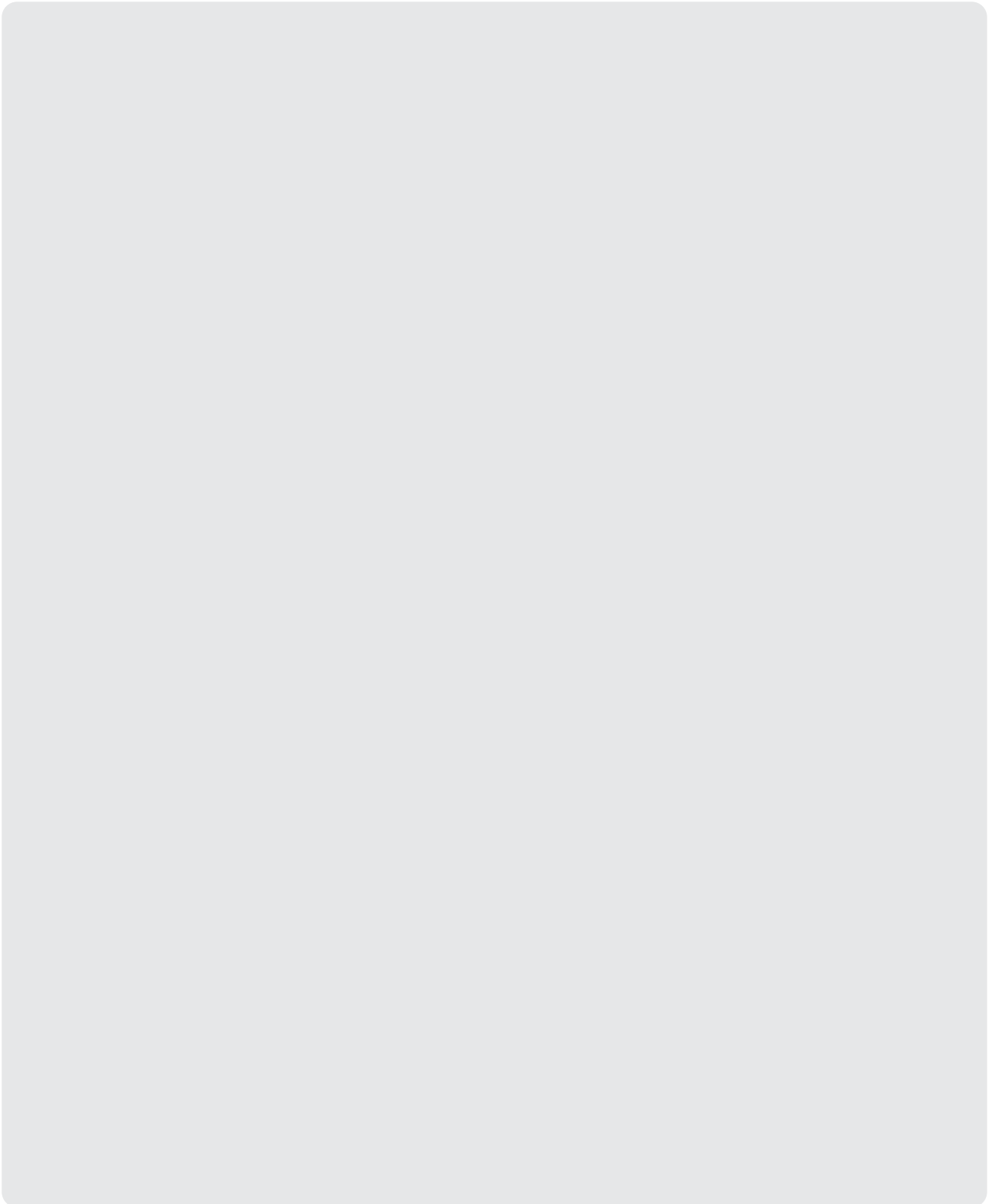

# Worldwide Network

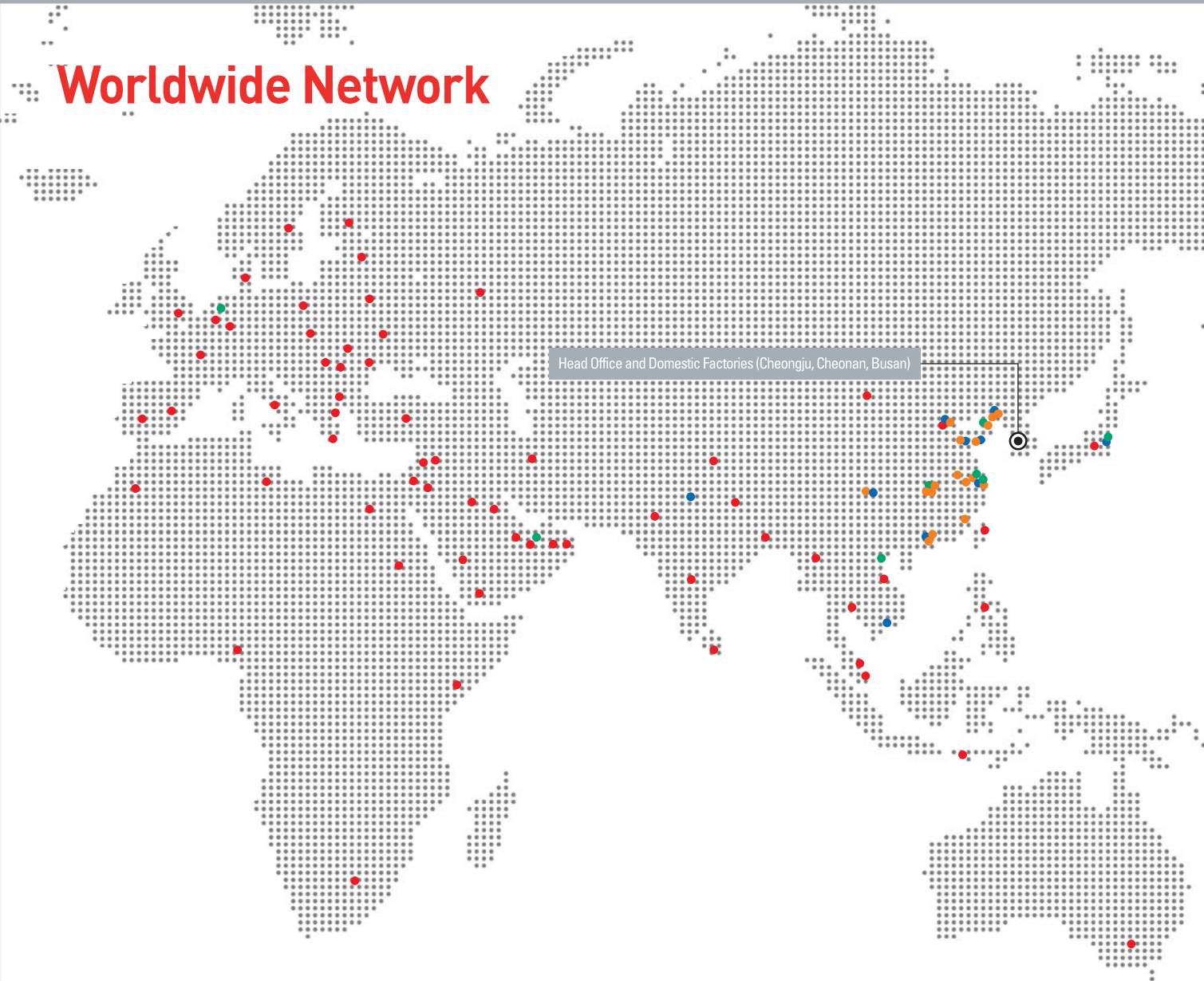

Head Office and Domestic Factories (Cheongju, Cheonan, Busan)

## Domestic Factories

- **Head Office**  
LS Tower, 127, LS-ro, Dongan-gu, Anyang-si, Gyeonggi-Do, 431-848, Korea  
Tel : 82-2-2034-4870 Fax : 82-2-2034-3660-7021
- **Cheongju Factory**  
1 Songjeong-dong, Cheongju-si, Chungbuk-do, 361-720, Korea  
Tel : 82-43-261-6114 Fax : 82-43-261-6602
- **Cheonan Factory**  
181 Samseong-ri, Mokcheon-myeon, Cheonan-si Chungnam-do, 330-840 Korea  
Tel : 82-41-550-8114 Fax : 82-41-566-8408
- **Busan Factory**  
1-19 Block Hwajeon-dong, Gangseo-gu, Busan, 618-280, Korea  
Tel : 82-51-795-6114 Fax : 82-51-795-6169

## Overseas Factories

- **Wuxi Factory, CHINA**  
102-A. National High & New Tech Industrial Development Area, Wuxi. Jiangsu. 214028. P.R. China  
Tel : 86-510-8534-6666 Fax : 86-510-8534-4078
- **Dalian Factory, CHINA**  
No. 15. Liaohexi 3-Road. Economic and Technical Development zone. Dalian 116600. China  
Tel : 86-411-273-7777 Fax : 86-411-8730-7560
- **Hanoi Factory, VIETNAM**  
Room 1311, 13th Floor, M3-M4 Building 91 Nguyen Chi Thanh street, Hanoi, Vietnam.  
Tel : 84-4-6275-8055 Fax : 84-4-6275-8056

## R&D Center

- **Advanced Technology R&D Center**  
533 Hogye-dong, Dongan-gu, Anyang-si, Gyeonggi-do, 431-749, Korea  
Tel : 82-31-450-7114
- **Electro Technology R&D Center**  
1 Songjeong-dong, Cheongju-si, Chungcheongbuk-do, 361-720, Korea  
Tel : 82-43-261-6114
- **Automation R&D Center**  
181 Samseong-ri, Mokcheon-myeon, Cheonan-si, Chungcheongnam-do, 330-840, Korea  
Tel : 82-41-550-8272
- **Power Testing & Technology Institute**  
1 Songjeong-dong, Cheongju-si, Chungcheongbuk-do, 361-720, Korea  
Tel : 82-43-261-6114



Cheongju Factory



Wuxi Factory (China)



Cheonan Factory



Dalian Factory (China)



Busan Factory



Hanoi Factory (Vietnam)



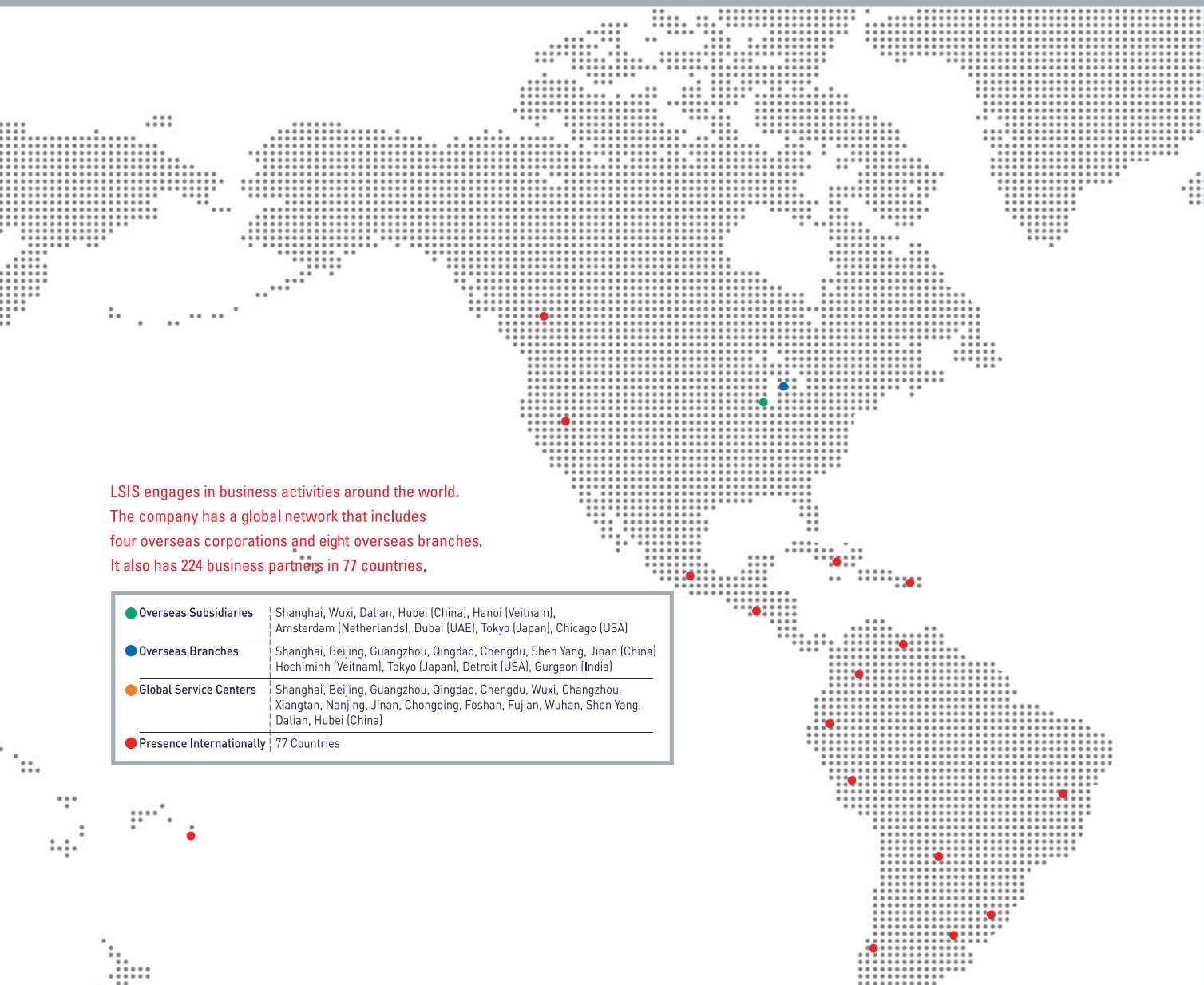

LSIS engages in business activities around the world.  
 The company has a global network that includes  
 four overseas corporations and eight overseas branches.  
 It also has 224 business partners in 77 countries.

● Overseas Subsidiaries	Shanghai, Wuxi, Dalian, Hubei (China), Hanoi (Vietnam), Amsterdam (Netherlands), Dubai (UAE), Tokyo (Japan), Chicago (USA)
● Overseas Branches	Shanghai, Beijing, Guangzhou, Qingdao, Chengdu, Shen Yang, Jinan (China) Hochiminh (Vietnam), Tokyo (Japan), Detroit (USA), Gurgaon (India)
● Global Service Centers	Shanghai, Beijing, Guangzhou, Qingdao, Chengdu, Wuxi, Changzhou, Xiangtan, Nanjing, Jinan, Chongqing, Foshan, Fujian, Wuhan, Shen Yang, Dalian, Hubei (China)
● Presence Internationally	77 Countries

### Overseas Subsidiaries

- LSIS(Shanghai) Co., Ltd. / CHINA  
32nd Room 1-4, 32/F, Great Wall Building, No.3000 North Zhongshan Road, Putuo District, Shanghai, P.R. China  
Tel : 86-21-5237-9977(609) Fax : 86-21-5237-7189
- LSIS(Dalian) Co., Ltd. / CHINA  
No. 15, Liaohexi 3-Road, Economic and Technical Development zone, Dalian, P.R. China  
Tel : 86-411-8731-7542 Fax : 86-411-8730-7560 E-Mail : dskim@lsis.com
- LSIS(Wuxi) Co., Ltd. / CHINA  
102-A, National High & New Tech Industrial Development Area, Wuxi, Jiangsu, P.R. China  
Tel : 86-510-8534-6666 Fax : 86-510-8534-4078 E-Mail : sojin@lsis.com
- LS Hukai Electric(Hubei) Co., Ltd. / CHINA  
No. 100, Tanjahe Road, Dianjun District, Yichang City, Hubei Province, P.R. China  
Tel : 86-717-667-7536 Fax : 86-717-667-7222 E-Mail : jaewoongh@lsis.com
- LS-VINA Industrial Systems Co., Ltd. / VIETNAM  
Room 1311, 13th, M3-M4 Building 91 Nguyen Chi Thanh street, Hanoi, Vietnam  
Tel : 84-4-6275-8055 Fax : 86-21-5237-7189
- LSIS[ME] FZE / U.A.E.  
LOB 19-205, JAFZA View Tower, Jebel Ali Free Zone, Dubai, United Arab Emirates  
Tel : 971-4-886-5360 Fax : 971-4-886-5361 E-Mail : shunlee@lsis.com
- LSIS Europe B.V. / NETHERLANDS  
1st. Floor, Tupolevlaan 48, 1119NZ, Schiphol-Rijk, The Netherlands  
Tel : 31-20-654-1420 Fax : 31-20-654-1429 E-Mail : junshickp@lsis.com
- LSIS Japan Co., Ltd. / JAPAN  
16th, Higashi-Kan, Akasaka Twin Tower, 2-17-22, Akasaka, Minato-ku, Tokyo, Japan  
Tel : 81-3-3582-9128 Fax : 81-3-3582-2667 E-Mail : jschuna@lsis.com
- LSIS USA Inc. / U.S.A.  
2000 Millbrook Drive, Lincolnshire, Chicago, IL 60069, United States of America  
Tel : 847-941-8240 Fax : 847-941-8259

### Overseas Branches

- LSIS Shanghai Office / CHINA  
Room E-G, 12th, Huamin Empire Plaza, No.726, West Yan'an Road, Shanghai, P.R. China  
Tel : 86-21-5237-9977(702) Fax : 86-21-5237-7189
- LSIS Beijing Office / CHINA  
Room 2306, Building B Landgent Center, No.24 Middle Road, East 3rd Ring Road, Chaoyang District, Beijing, P.R. China  
Tel : 86-10-5761-3127 Fax : 86-10-5761-3128 E-Mail : htroh@lsis.com
- LSIS Guangzhou Office / CHINA  
Room 1403, 14th, New Poly Tower, 2 Zhongshan Liu Road, Guangzhou, P.R. China  
Tel : 86-20-8326-6784 Fax : 86-20-8326-6287 E-Mail : sojhtroh@lsis.com
- LSIS Qingdao Office / CHINA  
Room 2001, Galaxy Building, 29 ShanDong Road, ShiNan District, QingDao, ShanDong, P.R. China  
Tel : 86-532-8501-6058 Fax : 86-532-8501-6057 E-Mail : htroh@lsis.com
- LSIS Chengdu Office / CHINA  
Room1710, 17/F Huamin Empire Plaza, NO.1 Fuxin Road, Chengdu, P.R. China  
Tel : 86-28-8670-3201 Fax : 86-28-8670-3203 E-Mail : yangcf@lsis.com
- LSIS ShenYang Office / CHINA  
Room 803, Hongyuan Building, 52 South Nanjing Road, Heping District, Shenyang, P.R. China  
Tel : 86-24 -2321-9050 Fax : 86-24 -8386-7210 E-Mail : yangcf@lsis.com
- LSIS Jinan Office / CHINA  
Room 417, Chuangzhan Center, No. 201, Shanda Road, Lixia District, Jinan, Shandong, P.R. China  
Tel : 86-531-8263-8026 Fax : 86-531-8263-8027 E-Mail : yangcf@lsis.com
- LSIS Tokyo Office / JAPAN  
16th, Higashi-Kan, Akasaka Twin Tower, 2-17-22, Akasaka, Minato-ku, Tokyo, Japan  
Tel : 81-3-3582-9128 Fax : 81-3-3582-2667
- LS-VINA Industrial Systems Hochiminh Office / VIETNAM  
4th, Yoco Building, 41 Nguyen Thi Minh Khai Street, Hochiminh City, Vietnam  
Tel : 84-8-3822-7941 Fax : 81-84-8-3822-7942 E-Mail : sjbaik@lsis.com
- LSIS Detroit Office / U.S.A.  
5700 Crooks Rd, Suite 211, Troy, MI 48098, United States of America  
Tel : 1-248-792-2637-8 Fax : 1-248-792-2642t E-Mail : sylee@lsis.com
- LSIS Gurgaon Office / INDIA  
109 First Floor, Park Central, Sector-30, Gurgaon- 122 002, Haryana, India  
Tel : +0091-124-493-0070 Fax : 91-1244-930-066 E-Mail : hwyim@lsis.com



### Safety Instructions

- For your safety, please read user's manual thoroughly before operating.
- Contact the nearest authorized service facility for examination, repair, or adjustment.
- Please contact qualified service technician when you need maintenance.  
Do not disassemble or repair by yourself !
- Any maintenance and inspection shall be performed by the personnel having expertise concerned.

## LSIS Co., Ltd.

© 2006. LSIS Co., Ltd. All Rights Reserved.

### HEAD OFFICE

LS Tower, 127, LS-ro, Dongan-gu, Anyang-si, Gyeonggi-Do, 431-848, Korea

■ Southeast Asia	+82-2-2034-4888	cshwang@lsis.com (Charles Hwang)
■ Europe	+82-2-2034-4676	sukyong@lsis.com (Brian Choi)
■ Turkey/Israel/CIS	+82-2-2034-4879	dkimcd@lsis.com (Daniel Kim)
■ Oceania	+82-2-2034-4394	kacho@lsis.com (Kendra Cho)
■ North/Latin America	+82-2-2034-4286	hkchung@lsis.com (Hank Raul Chung)
■ Southwest Asia/Africa	+82-2-2034-4467	myleed@lsis.com (Henry Lee)
■ Middle East	+971-4-886-5360	khchoi1@lsis.com (Lambert Choi)

### Overseas Subsidiaries

- **LSIS USA Inc., Chicago, U.S.A.**  
2000 Millbrook Drive, Lincolnshire, Chicago, IL 60069, United States  
Tel : 847-941-8240 Fax : 847-941-8259
- **LSIS(ME) FZE Dubai, U.A.E.**  
LOB 19-205, JAFZA View Tower, Jebel Ali Free Zone, Dubai, United Arab Emirates  
Tel : 971-4-886-5360 Fax : 971-4-886-5361
- **LSIS(Shanghai) Co., Ltd., Shanghai, China**  
32nd Floor, International Corporate City, No.3000 NorthZhongshan Road, Putuo District, Shanghai, China, 200063  
Tel : 86-21-5237-9977-8609 Fax : 86-21-5237-7189
- **LSIS(Dalian) Co., Ltd., Dalian, China**  
No. 15, Liaohexi 3-Road, Economic and Technical Development Zone, Dalian 116600, China  
Tel : 86-411-8730-7510 Fax : 86-411-8730-7560
- **LSIS(Wuxi) Co., Ltd., Wuxi, China**  
No. 1, Lexing Road, Wuxi National High & New Tech Industrial Development Area, Wuxi214028, Jiangsu, P.T.China  
Tel : 86-510-8534-6666-8005 Fax : 86-510-8534-4078
- **LS Hukai Electric(Hubei) Co., Ltd., Hubei, China**  
No. 100, Tanjiahe Road, Dianjun District, Yichang City, Hubei Province, 443004, China  
Tel : 86-717-667-7339 Fax : 86-717-667-7559
- **LS-VINA Industrial Systems Co., Ltd., Hanoi, Vietnam**  
Nguyen Khe, Dong Anh, Hanoi, Vietnam  
Tel : 84-4-6275-8055 Fax : 84-4-3882-0220
- **LSIS Europe B.V., Netherlands**  
1st Floor, Tupolevlaan 48, 1119NZ, Schiphol-Rijk, The Netherlands  
Tel : 31-20-654-1420 Fax : 31-20-654-1429
- **LSIS Japan Co., Ltd., Tokyo, Japan**  
Tokyo Club Building 13F, 2-6, Kasumigaseki 3-chome, Chiyoda-ku, Tokyo, 100-0013  
Tel : 81-3-6268-8241 Fax : 81-3-6268-8240

### Overseas Branches

- **LSIS Detroit Office, U.S.A.**  
5700 Crooks Rd, Suite 211, Troy, MI 48098, USA  
Tel : 1-248-792-2637-8 Fax : 1-248-792-2642
- **LSIS Shanghai Office, China**  
32nd Floor, International Corporate City, No.3000 NorthZhongshan Road, Putuo District, Shanghai, China, 200063  
Tel : 86-21-5237-9977 Fax : 86-21-5237-7189
- **LSIS Beijing Office, China**  
Room 2306, Building B Landgent Center, No.24 Middle Road, East 3rd Ring Road, Chaoyang District, Beijing, P.R. China  
Tel : 86-10-5761-3127 Fax : 86-10-5761-3128
- **LSIS Guangzhou Office, China**  
Room 1818-1820, Xinyuan Building, NO.898 Tianhe North Road, Tianhe District, Guangzhou, P.R. China  
Tel : 86-20-8326-6784 Fax : 86-20-8326-6287
- **LSIS Chengdu Office, China**  
Room 1710, 17/F Huamin Empire Plaza, NO.1 Fuxin Road, Chengdu, P.R. China  
Tel : 86-28-8670-3200 Fax : 86-28-8670-3203
- **LSIS Qingdao Office, China**  
Room 2001, Galaxy Building, 29 ShanDong Road, ShiNan District, QingDao, ShanDong, P.R. China  
Tel : 86-532-8501-6058 Fax : 86-532-8501-6057
- **LSIS ShenYang Office, China**  
Room 803, Hongyuan Building, 52 South Nanjing Road, Heping District, Shenyang, P.R. China  
Tel : 86-24-2321-9050 Fax : 86-24-2321-9050
- **LSIS Jinan Office, China**  
Room 317, Chuangzhan Center, No. 201, Shanda Road, Lixia District, Jinan, Shandong, P. R. China  
Tel : 86-531-8699-7826 Fax : 86-531-8697-7628
- **LSIS Co., Ltd. Rep. Office, Vietnam**  
Gema Dept Tower 18F, 6 Le Thanh Ton, District 1, HCM, Vietnam  
Tel : 84-8-3823-7890 Fax : -
- **LSIS Co., Ltd. Tokyo Office, Japan**  
Tokyo Club Building 13F, 2-6, Kasumigaseki 3-chome, Chiyoda-ku, Tokyo, 100-0013  
Tel : 81-3-6268-8241 Fax : 81-3-6268-8240
- **LSIS Co., Ltd. India Office, India**  
109 First Floor, Park Central, Sector-30, Gurgaon- 122 002, Haryana, India  
Tel : 91-1244-930-077 Fax : 91-1244-930-066
- **LSIS Moscow Office, Russia**  
123610, Krasnopresnenskaya, nab., 12, building 1, office 41005, Moscow, Russia  
Tel : 7-495-258-1466/1467 Fax : 7-495-258-1466/1467
- **LSIS U.K. Office, United Kingdom**  
G17 Bedford I-Lab, Stannard Way, Priory Business Park, Bedford, MK44 3RZ, U.K.  
Tel : 44-012-3483-4774 Fax : 44-012-3483-4775

Specifications in this catalog are subject to change without notice due to continuous product development and improvement.